

castle
COMPOSITES

PRODUCT CATALOGUE
2024/25

castle COMPOSITES

Samples

As photographs cannot always show the true colour and texture of our products we are always happy to supply samples.

To order samples please contact us via phone or email to arrange delivery.

Samples are sent via 24 hour courier to keep delivery time to a minimum.

Samples are free of charge for UK mainland addresses for the first request.

Delivery

Our products are delivered stacked on wooden pallets.

Smaller orders may be delivered by courier.

Delivery is normally free of charge for orders of full pallets or more being delivered to UK mainland addresses.

Deliveries are made by curtain sided truck with tail lift if required.

Deliveries can be made in as little as 24 hours however the standard delivery time is 2-3 days.



Castle Composites Ltd
Nisbet Way, Ravenstruther
Lanark ML11 7SF

Tel: 01555 870 003
Fax: 01555 870 040

Email: sales@castlecomposites.co.uk
Web: www.castlecomposites.co.uk



About us

At Castle Composites, we are a business with a proud history of delivering excellent levels of service and innovative product solutions for our customers since our launch in 1998.

The company was formed in 1998 with the initial purpose of manufacturing GRC Promenade Tiles, we have sales of over 4m units in that product line to date, a clear indicator of sustained quality. The company remains a family owned business with a focus on delivering value for our customers.

Castle Composites is Quality Assured to ISO 9001:2015 ensuring strong customer focus, continual improvement and quality management throughout the business.

Products and service

Changes in the Flat Roofing market have necessitated new product development and diversification, with the company now offering a comprehensive range of products for flat roofing, balconies, patios, landscaping and beyond. We are continually working to improve our range and our quality standards wherever possible.

Team

We are a family owned business now into the second generation, the business was founded by David Snr. As an engineer David had a distinguished career to senior management and director level within a FTSE50 company in the concrete industry and used this experience to build the business with a focus on quality and service.

The business is now operated by David's sons, David Jnr and Gordon. Also with a background in engineering, Gordon joined the business in 2009 as General Manager and has overseen the development of much of the expanded product range, developing a high level of industry expertise. David Jnr joined the business in 2017, as a Chartered Accountant, David had a 15 year career to senior management level in Audit, Financial Reporting and Control.

The leadership team are supported by experienced and motivated sales, production and distribution staff. Several of our team members have been with us for many years, including one since inception, fostering high levels of knowledge throughout the operation and allowing us to provide excellent service to our customers.

Our products are now available on NBS Plus and the National BIM Library



Contents

	Page
Promenade Tiles	2-6
Promenade Slabs	7-10
Coping Stones	11
Concrete Wall Block	12
Porcelain Coping Stones	13
Granite Coping Stones and Pier Caps	14
Coping Stone Accessories	15
Castle Porcelain Paving	16
Extra 20 Porcelain	17-18
Compact 20 Porcelain	19
Contract 20 Porcelain	20
Porcelain Border Edge Tiles	21
Paving Support Pads	22-23
Adjustable Pedestals	24-27
Spiral and Raptor Adjustable Supports	28
DD Maxi Adjustable Pedestals	29
A1 Fire Rate ALU Adjustable Pedestals	30
Castleflex Rubber Tiles	31-33
Castleflex EPDM Rubber Tiles	34-35
Grassflex Tiles	36
Rubber Roof Walkway Tiles	37
Castlewood Composite Decking	38
Forest Decking Boards	39
Polymer Capped Decking Boards	40
Composite Deck Tiles	41
Castlewood Railing System	42
Ultraguard Composite Fencing	43
Castle Composite Cladding	44
Aslon® Terrace Substructure System	45
Aslon® Any Deck - Porcelain Tile Substructure	46
Aslon® Any Deck - Substructure Component Parts	47
Artificial Grass	48-49
Grassforce Rubber Matting	50
Gravel Grids	51
Grassflex Play	52
dFLECT SBR Rubber	53
dFLECT EPDM	54
Playground Accessories	55
Puzzle Gym Floor Tiles	56
Fine Granulate Gym Tiles	57
Rubber Equestrian Tiles	58
Acoustic Protection	59
Ladder Mats	60



Promenade Tiles

Glass Fibre Reinforced Concrete Promenade Tiles

Castle Composites Ltd are pleased to present the “Castile” range of Promenade Tiles manufactured to the highest standards under BS EN ISO 9001: 2015 certification to ensure complete customer satisfaction. Castile tiles are produced from a blend of Silica Sand, High Strength Granite, Top Quality Cement, Glass Fibre and product enhancing additives. This attention to the mix constituents

ensures, through a regime of regular testing, that the tiles delivered to you are strong, durable and can be used with complete confidence.

Promenade Tiles have traditionally been used in the roofing industry to great effect where attractive weatherproof and durable surfaces are required. Promenade Tiles provide crucial protection to the waterproofing membrane beneath from foot traffic and Ultra Violet degradation.

As well as offering excellent protection, Castile Promenade Tiles are very lightweight meaning that minimal loads will be applied to the structure and, starting at 12mm thick, they can be used in areas where low threshold levels are a problem.

Promenade Tiles can be laid on many surfaces. Please see our surface guide on page 6 for more information or feel free to call and discuss.

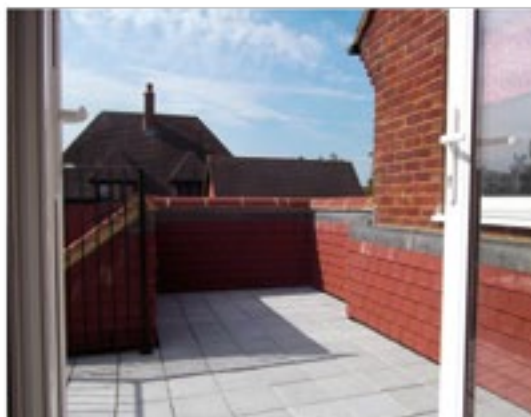



Checkerplate

The “Castile” Checkerplate finish has been available for some years now and is chosen throughout the flat roofing industry when a durable, practical and highly slip resistant surface is required.

Our unique edge detail helps avoid the unsightly steps between tiles when laying on a slightly uneven surface.

Checkerplate Slip Resistance: 52 Wet (Low Potential For Slip) tested in accordance with BS 7976 Pendulum Test.

Size: 297 x 297 x 12mm.
Weight: 2.0kg per tile approx.
11 tiles per m2.

1. Light Grey; 2. Buff; 3. Green; 4. Dark Grey; 5. Grey Marbled; 6. Terracotta; 7. Red; 8. White; 9. Terracotta Marbled

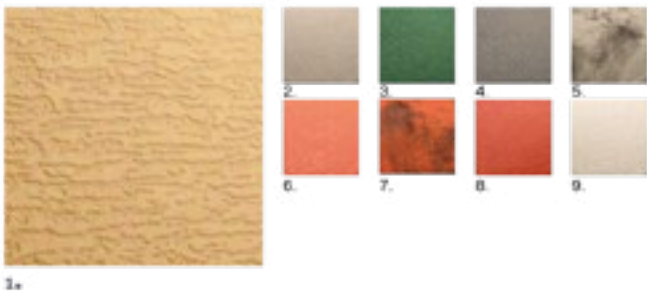

Striated

Our Striated finish is a firm favourite with many of our customers and is often described as having a “bark” like finish.

It is the combination of attractive texture, high slip resistance, durability and high strength synonymous with “Castile” Striated tiles that make them highly popular.

The extensive range of colours available gives excellent scope to find just the right colour for your application.

Striated Slip Resistance: 58 Wet (Low Potential For Slip) tested in accordance with BS 7976 Pendulum Test.

Size: 297 x 297 x 12mm Weight:
2.0kg per tile approx
11 tiles per m2

1. Buff; 2. Light Grey; 3. Green; 4. Dark Grey; 5. Grey Marbled 6. Terracotta; 7. Terracotta Marbled; 8. Red; 9. White

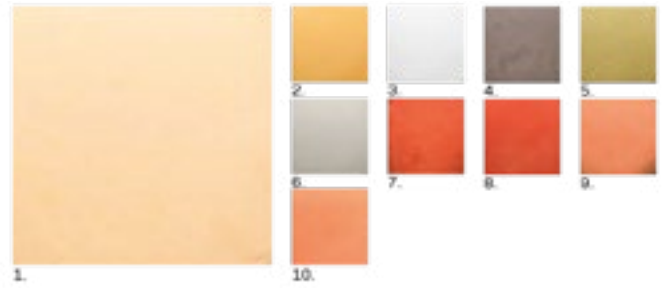

Imperial

The Imperial surface finish is the most contemporary in the range and, although this tile looks smooth, it has a very subtle split stone effect which gives some slip resistance.

Exclusive to the Imperial surface finish are our “aged” colours which are designed to mimic “aged” quarry tiles for a rustic feel but still retaining all the benefits of GRC Promenade Tiles.

Size: 297 x 297 x 12mm.
Weight: 2.0kg per tile approx.
11 tiles per m2.

1. Champagne; 2. Buff; 3. White; 4. Charcoal; 5. Green; 6. Light Grey; 7. Red Aged; 8. Red; 9. Terracotta Aged; 10. Terracotta



Riven

The Riven finish is an excellent example of the texture, warmth and practicality of natural stone combining with the durability and strength of Glass Fibre Reinforced Concrete to produce a product which gives the very best attributes of both worlds.

The use of numerous mould finishes means that the repetitive nature of some products is avoided, giving a more natural appearance.

The Riven finish is also available in a variety of sizes allowing different patterns to be created.

Standard Size: 294 x 294 x 14mm.
Weight: 2.2kg per tile approx.
Slip resistance: 42 Wet (Low Potential for Slip)
Also Available: 147 x 147; 147 x 294; 294 x 440

1. Red Sandstone; 2. Light Grey; 3. Old Gold; 4. Weathered Stone; 5. White; 6. Grey Marbled; 7. Terracotta; 8. Terracotta Marbled; 9. Slate; 10. Champagne

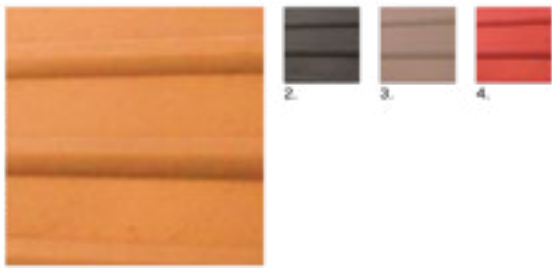

1.

Tactile

The Equality Act 2010 places an obligation on service providers to ensure that their services to the disabled are amenable and acceptable.

Compliance should take the form of Tactile surfaces in places such as at the top and bottom of stairs and steps and at the foot of ramps, etc.

In considering the roofing industry in particular we have recognised that this requirement could have far reaching consequences on flat roofs and balconies, and we have therefore developed a Glass Fibre Reinforced Concrete tile which fits to the 300 x 300 grid pattern of our standard Promenade Tiles.

This development will allow you to comply with the requirement for tactile surfaces in areas where promenade tiles are to be fitted.

1. Buff; 2. Dark Grey; 3. Light Grey; 4. Red



1.

Diamond Cut

Our Diamond Cut Range of Promenade Tiles are designed to mimic traditional Victorian diamond paving. The cuts in the tile surface help to keep rainwater from the walking surface as well as creating the diamond pattern.

Our unique edge detail helps avoid the unsightly steps between tiles when laying on a slightly uneven surface.

Size: 297 x 297 x 12mm. Weight: 2.0 kg per tile approx. 11 tiles per m2.

1. White; 2. Buff; 3. Charcoal; 4. Green; 5. Light Grey; 6. Terracotta

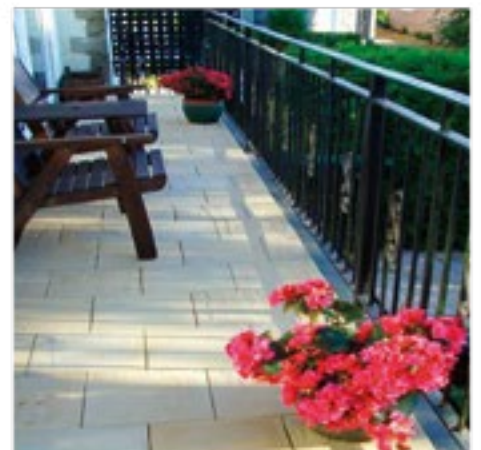
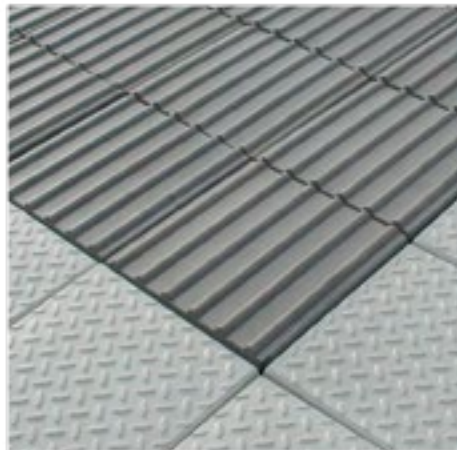

Accessories



XP 2265 PU Adhesive

Specially designed to adhere Castile Promenade Tiles to bituminous felt roofs, sanded asphalt and almost all other flat roof surfaces. (Please see Suitable Surfaces section or contact us if you are unsure of application).

During curing, the adhesive absorbs moisture from the atmosphere and expands providing a firm support to the tile. This results in an effective and practical fixing method which can be used in damp and humid conditions. When cured the adhesive retains sufficient flexibility to allow for the thermal and structural movement of the tiles and roof. PU adhesive is supplied in 1 litre bottles with nozzle. One bottle will adhere approximately 50 tiles or 5m². The adhesive is applied by simply cutting the nozzle to get a 3-4mm bead and applying as per the diagram. It is very important that the adhesive is applied as per the instructions.

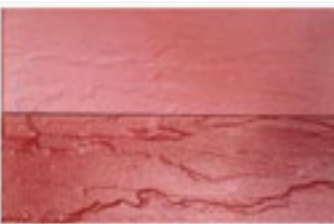

Promseal

Promseal is a specially formulated Acrylic Resin which can be applied to our promenade tiles when laid. The picture adjacent shows a half sealed tile.

When applied the coating leaves the tiles with a silk finish which is easier to clean and is resistant to most domestic stains, motor oils and foodstuffs and also controls algae growth. Promseal is supplied in 1 litre bottles. One bottle will seal approximately 60 tiles. Slip resistance may be affected. Please call for more information.



Promclean

Promclean is a specially blended cleaner for use with GRC Promenade Tiles. Promclean helps to remove general dirt, efflorescence and many other stains. Supplied in 1 litre bottles the cleaner will be sufficient for approximately 80 tiles.

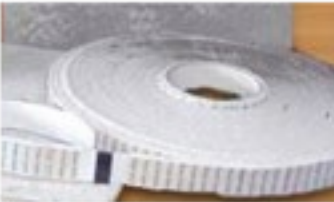

Soft Packers

Soft Packers are available for packing under tiles when an uneven surface exists (e.g. overlapping felt)

The Soft Packers are self adhesive with release tape on both sides. Made from soft foam rubber they measure 3mm thick x 12mm wide by 25mm long.

Note: When using soft packers you may require more adhesive than indicated.



2mm Long Leg Spacers

Our 2mm long leg spacers are ideal for achieving the correct gap between tiles. Unlike standard tile spacers they have extra long legs for use with our Promenade Tiles.

Spacers are available in bags of 250, 500 and 1000.

Using Castle Promenade Tiles

Hot Bitumen must not be used as the fixing medium on asphalt substrates. It can be used on felt roofs but care must be taken with weather conditions and the application of bitumen to ensure that the whole of the tile surface is fully bonded.

Cold bitumen should only be used to adhere tiles with the express approval of the manufacturer. Solvents contained in some cold bitumen adhesives can damage felt and asphalt.

Due to the high cement content of Castile Promenade Tiles there is a possibility that efflorescence or staining may appear on the tiles if water has been allowed into the stack but evaporation has been restricted. The strength and other properties of the tiles will not be affected.

Promenade Tiles are manufactured from naturally occurring materials and are therefore liable to colour differences caused through variation in the raw materials and differential drying conditions. These variations are beyond the control of the manufacturer. Promenade Tiles displaying unacceptable degree of variation should not be laid and the advice of the manufacturer should be sought. No responsibility will be accepted for the consequences of variation in tile colour.

Promenade Tiles are stacked on pallets and shrink wrapped soon after manufacture to provide optimum curing conditions. As a result they may not display their true colour until they have been exposed to weathering and sunlight.

Promenade Tiles are not suitable for use on paving support pads. If you require a product for use on paving support pads you must use our Promenade Slabs. Promenade Slabs are manufactured to cope with the stresses and strains of being supported only at the corners whereas Promenade

Tiles are designed to be adhered. Please call for more information.

Care should be taken to allow for any variation in shade and for manufacturing tolerances in size and thickness when laying tiles.

Promenade Tiles are supplied from our works on wooden pallets and are covered with plastic shrink-wrap bags. Pallets must not be stored more than two high and point loading must be avoided or damage to tiles will occur. Pallets of tiles must be protected and stored in dry conditions or efflorescence, discolouration and staining may result.

Do not allow dirt or contaminants to build up in the gaps between tiles as this can cause staining. If contamination of tiles is likely to occur it may be advisable to seal with Promseal when laid. Acid based cleaners must not be used on tiles.

This information and any recommendations or suggestions contained herein are given in good faith without warranty or guarantee as conditions of use are outwith our control. Product development is continuous and tiles are subject to change without notice. Please ensure that our products will be suitable for use by requesting samples for your evaluation relating to colour and working conditions.

All tiles are sold in accordance with our terms and conditions of sale which are available on request.

Castle Composites Ltd. are pleased to Guarantee our Promenade Tiles against manufacturing fault for a period of 10 years from date of supply. Full terms and conditions available on request.

Laying Instructions

Preparation

Ensure surface to be covered is free from dust, grease and all loose materials.

Where appropriate ensure efficient drainage to area.

Recommended falls minimum 1:80, maximum 1:40.

Inspect existing surface or roof covering and ensure that all necessary remedial works are carried out prior to work commencing.

Mark out area to be tiled allowing for 2mm joints between tiles to accommodate movement, drainage and tolerances.

Laying Tiles

Always work away from tiled areas to avoid traffic on areas which are not fully adhered. Do not stand on recently laid tiles.

Avoid point support of tiles at all times. Ensure that the tile is supported over the entire underside.

When cutting tiles ensure that dust created is not allowed to build up on completed areas as staining may occur. Tiles should be cut dry using a diamond tip blade or similar.

When applying the PU adhesive it is vital that the instructions are followed. Adhesive should be applied to the back of the tile via three zigzag lines with a 3mm bead of adhesive. Zigzags should start 20mm from the edge of the tile as shown in the diagram.

Any PU adhesive that foams up between the gaps should be left to cure for a minimum 24 hrs and then removed with a sharp blade.

Zigzag lines should then be pointed towards the fall of the balcony/ roof where possible to allow the water to flow through gaps between zig zags.

When laying tiles on a surface where variations in level exist (e.g. Overlapping Felt) our soft packers can be used to overcome these differences up to 6mm.

Soft Packers should be applied to the back of the tile where required to achieve a level surface. Do not use more than two soft packers on top of each other. Where required apply slightly more PU adhesive. The adhesive will then foam up to support the tile in the required position.

Full instruction for using Soft Packers can be found online.

Adhesive should be allowed 48 hrs to cure before trafficking.



SUITABLE SURFACES

Bituminous Felt

Promenade Tiles can be used on both butt joined and overlapping felt by simply applying the tiles with our XP 2265 PU Adhesive following the instructions.

Any slight undulations or overlaps in the felt can be overcome using our soft packers.

Asphalt

When using Promenade Tiles on Asphalt our XP 2265 PU Adhesive MUST be used as the fixing method. Simply apply to the tiles as per the standard instructions. Hot bitumen must NOT be used on asphalt. Any slight undulations can be overcome using soft packers.

Concrete

When using Promenade Tiles on Concrete our XP 2265 PU Adhesive should be used as the fixing method following the instructions.

Any slight undulations can be overcome using soft packers.

Fibre Glass

Promenade Tiles can be adhered to Fibre Glass roof systems using XP 2265 PU Adhesive. It is necessary to ensure that any release vapours have been allowed to dissipate before adhering the tiles. This can be up to 14 days from Fibre Glass being laid. If the surface is very glossy then a light abrasion may be required to ensure best adhesion.

EPDM/Rubber

Promenade Tiles can be fixed to most rubber surfaces without any problems using our PU Adhesive, although some EPDM types may require some surface treatments. For further advice on fixing to rubber please contact us to discuss.

Single Ply

Whilst it is unlikely that any problem will arise from the use of PU Adhesive when using Promenade Tiles on single ply membranes it is necessary to check with the manufacturer that they accept the use of PU Adhesive. If this is not acceptable our Promenade Slab system will provide an acceptable solution. Please call for more information.

Lead

When using Promenade Tiles on Lead it is necessary to ensure that the surface is not excessively oxidised as this will effect adhesion when using our PU Adhesive. If the surface is new then it is unlikely to be the case but with older lead the oxidation can be seen as a whitish dust.

For advice on oxide removal please contact us.

Timber

When using Promenade Tiles on Timber it is recommended that our PU Adhesive is used as the fixing method. Simply apply the tiles as per the instructions.



Promenade Slabs

Castle Pave Promenade Slabs

The Castle Pave Promenade Slab System allows drainage outlets, conduits and pipes to be covered without the need to use adhesives in contact with the surface. The System provides protection from mechanical damage, ultra violet light degradation and temperature extremes. This System also ensures

adequate drainage between and under slabs, prevents the build up of top surface standing water and reduces the likelihood of plant growth. Installation is simple, resulting in reduced equipment, on site time and labour requirements. The Castle Pave Promenade Slabs System allows drainage outlets, conduits and pipes to be concealed below the slabs leaving them safe, accessible and unobstructed. The promenade

slab system can be laid to existing falls or, using adjustable supports, the walkway can be laid level taking up drainage falls or general unevenness in the roof surface. Additionally, slabs can be removed at any time to allow access to the substrate or to allow the slabs to be moved, patterns changed or colours changed.

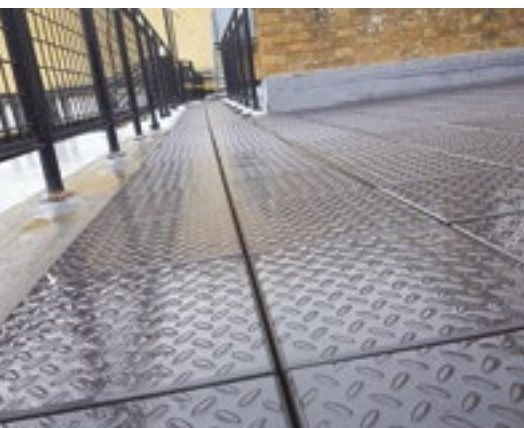

Castle Pave 300 x 300 Promenade Slabs

The 20mm thick 300 x 300mm Promenade Slabs have been specially designed to be used with Paving Support Pads. They can of course still be fixed direct to the roof surface with PU Adhesive but using the Paving Support Pads allows them to be used in any situation where direct contact with the waterproofing membrane is to be avoided, such as with some single ply membrane systems. This system also gives the freedom of being able to remove the tiles for inspection, services, repairs and many other reasons. The tiles are tested internally and externally and average breaking loads of 300kg are achieved.

Our 300 x 300 range are particularly suited to applications where low threshold level or low weight is required.



1. Checkerplate

Size: 297 x 297 x 20mm; Weight: 4.1kg Per Slab Approx
No Per m2: 11; Slip Resistance: 52 WET (Low Potential For Slip)

1. Terracotta; 2. Green; 3. Dark Grey; 4. Grey Marbled; 5. Terracotta Marbled; 6. Light Grey; 7. Red; 8. White; 9. Buff



1. Striated

Size: 297 x 297 x 20mm; Weight: 4.1kg Per Slab Approx
No Per m2: 11; Slip Resistance: 58 WET (Low Potential For Slip)

1. Green; 2. Buff; 3. Dark Grey; 4. Grey Marbled; 5. Terracotta Marbled; 6. Light Grey; 7. Red; 8. White; 9. Terracotta



1. Riven

Size: 294 x 294 x 22mm; Weight: 4.2kg Per Slab Approx
No Per m2: 11.5; Slip Resistance: 42 WET (Low Potential For Slip)

1. Champagne; 2. Grey Marbled; 3. Red; 4. Slate; 5. Terracotta Marbled; 6. Light Grey; 7. White; 8. Old Gold; 9. Terracotta

Castle Pave 450 x 450 Promenade Slabs

All our 450 x 450mm Promenade Slabs are manufactured and tested in accordance with BS 1339. This ensures that our slabs are strong, durable and slip resistant and can be installed on a flat roof or balcony with complete confidence. The 450 x 450 range also incorporates a notched side wall detail to accommodate the support pad lugs giving smaller gaps between each slab and a safer and more attractive walking surface.

Our 450 x 450mm Promenade Slabs can be laid using our range of support pads or they can be loose laid as ballast as they meet the wind uplift requirements of 80kg per m2.

Starting at only 16kg each they are also very easy to handle and are under the 25kg lifting limit recommended by the Health & Safety Executive.

1. **Pebble**

Size: 445 x 445 x 38mm;
Weight: 16kg Approx
Composition: Glass Fibre Reinforced Concrete
No Per m2: 5; Slip Resistance: 52 WET (Low Potential For Slip)
BS EN 1339 Marking: AIKPU4

1. **Riven**

Size: 445 x 445 x 38mm; Weight: 16kg Approx
Composition: Glass Fibre Reinforced Concrete;
No Per m2: 5
Slip Resistance: 58 WET (Low Potential For Slip)
BS EN 1339 Marking: AIKPU4

1. **Riven**

Size: 445 x 445 x 38mm; Weight: 16kg Approx
Composition: Glass Fibre Reinforced Concrete;
Slip Resistance: 42 WET (Low Potential For Slip);
BS EN 1339 Marking: AIKPU4

1. **Pebble**

Size: 445 x 445 x 38mm; Weight: 16kg Approx
Composition: Glass Fibre Reinforced Concrete;
No Per m2: 5
Slip Resistance: 66 WET (Low Potential For Slip)
BS EN 1339 Marking: AIKPU4

1. Dark Grey; 2. Light Grey; 3. Old Gold; 4. Grey Marbled

1. Grey Marbled; 2. Light Grey; 3. Old Gold; 4. Dark Grey

Castle Pave 600 x 600 Promenade Slabs

The Castle Composites range of 600 x 600 Promenade Slabs are available in both the Striated and Pebble surface finishes. The range of colours on offer ensure that you can find the right colour to blend or contrast with the balcony or flat roof surroundings.

Both 600 x 600 Promenade Slabs have our unique notched edge detail, these notches accommodate the

support pad lugs which keeps the gaps between each slab to a minimum, making the surface more attractive and safer to use.

By choosing the 600 x 600 size you will be minimising the number of support pads used. This can offer substantial savings particularly when working with the more expensive adjustable support pads. As with all our products, samples are available on request to allow comparison and confirmation of colour and surface finish.

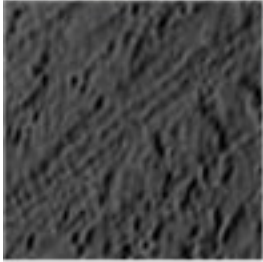

1.
Striated

Size: 593 x 593 x 38mm; Weight: 29kg approx
Composition: Glass Fibre Reinforced Concrete; No Per m2: 2.80
Slip Resistance: 58 Wet (Low Potential for Slip)

1. Dark Grey; 2 Light Grey, 3. Grey Marbled; 4. Old Gold



1.
Pebble

Size: 593 x 593 x 38mm; Weight: 29kg approx
Composition: Glass Fibre Reinforced Concrete; No Per m2: 2.8
Slip Resistance: 66 Wet (Low Potential for Slip)

1. Old Gold; 2 Light Grey, 3. Grey Marbled; 4. Dark Grey



Installation

Below is a very brief description of the installation procedure for Promenade Slabs. For full details please contact us or visit our website.

1. Ensure roof surface is sound, clean and has good drainage.
2. Lay out protective cover where required by waterproofing manufacturer.
3. Mark out centre lines in both directions and adjust to ensure any cut slabs at edges are no less than 1/2 slab where possible.
4. If laying slabs to follow the profile of the roof surface then simply lay out Paving Support Pads on, or on both sides of the centre lines and lay slabs on top, working in both directions to ensure straight lines are maintained.
5. If any low areas are encountered use levelling discs or additional stackable Paving Support Pads to bring slab level up to that required. If there are obvious high points then it may be necessary to start from there so that low areas can be lifted by levelling discs and pads.
6. If slabs are to be cut to fit at edges, always place an additional support pad under the centre of the cut slab to reinforce.
7. When working to an open or unrestrained edge it is necessary to ensure sufficient edge restraint to avoid movement of slabs. Please call to discuss your specific layout details.
8. When laying slabs to achieve a level top surface, start laying slabs at the highest point, checking with a spirit level and adjusting height with support pads and levelling discs as you progress.
9. For areas where higher than 60mm of lift is required (4 no 15mm stackable pads) adjustable support pads should be used.



Using Castle Promenade Slabs

Castle Promenade Slabs are manufactured to the highest quality standards and are produced from a blend of Sand, High Strength Granite, Top Quality Cement, Glass Fibre and product enhancing additives. This attention to the mix constituents ensures, through a regime of regular testing, that the slabs delivered to you are strong, durable and can be used with complete confidence.

Ensure surface to be covered is free from dust, grease and all loose materials.

Where appropriate ensure efficient drainage to area - recommended minimum 1:80 maximum 1:40.

Inspect existing surface or roof covering and ensure that all necessary remedial works are carried out prior to work commencing.

When cutting slabs ensure that the dust created is not allowed to build up on completed areas as staining may occur. Cut slabs may require additional support, please call for details.

Due to the high cement content of Castle Promenade Slabs there is the possibility that efflorescence or staining may appear on tiles if water has been allowed into the stack but evaporation has been restricted. The strength and other properties of the slab will not be affected. Efflorescence will not be considered as a fault.

Promenade Slabs are manufactured from naturally occurring materials and are therefore liable to colour differences caused through variation in the raw materials and differential drying conditions. These variations are beyond the control of the manufacturer. Promenade Slabs displaying unacceptable degree of variation should not be laid and the advice of the manufacturer should be sought. No responsibility will be accepted for the consequences of variation in slab colour.

Care should be taken to allow for any variations in shade and for manufacturing tolerances in size and thickness when laying slabs.

Promenade Slabs are stacked on pallets and shrink wrapped soon after manufacture to provide optimum curing conditions. As a result they may not display their true colour until they have been exposed to weathering and sunlight.

Promenade Slabs are supplied from our works on wooden pallets and are covered with plastic shrink-wrap bags. Pallets must not be stored more than two high and point loading must be avoided or damage to slabs will occur. Pallets of slabs must be protected and stored in dry conditions or efflorescence, discolouration and staining may result.

Do not allow dirt and other contaminants to build up in the gaps between slabs as this can cause staining. If contamination of slabs is likely to occur it may be advisable to seal with Promseal when laid. Acid based cleaners or high pressure water sprays must not be used on slabs.

This information and any recommendations or suggestions contained herein are given in good faith without warranty or guarantee as conditions of use are outwith our control. Product development is continuous and slabs are subject to change without notice. Please ensure that our products will be suitable for use by requesting samples for your evaluation relating to colour and working conditions.

All slabs are sold in accordance with our Terms and Conditions of Sale which are available on request.

Castle Composites Ltd. are pleased to Guarantee our Promenade Slabs against manufacturing fault for a period of 10 years from date of supply. Full terms and conditions available on request.



Concrete Coping Stones and Pier Caps

Castle coping stones and pier caps are manufactured and designed for use on garden walls, parapet walls and flat roofs. All coping stones have drip checks on both sides. The centre of the drip check is located approximately 20mm from the edge of the coping stones and pier caps. Our single weathered coping stones are designed to shed rainwater water to one side of the wall.

All our coping stones and pier caps are manufactured from high strength concrete. Available in light grey, buff and dark grey colours. Stacked on wooden pallets then shrink wrapped for transport. Full pallet quantities are delivered free of charge. Part pallet orders can be arranged.



Twice Weathered

- 175 x 600mm 30-50m, 10kg approx
- 230 x 600mm, 30-50mm, 11kg approx
- 300 x 600mm, 30-50mm, 16kg approx
- 375 x 600mm, 30-50mm, 21kg approx
- 450 x 600mm, 50-70mm, 37kg approx

Single Weathered

- 300 x 600mm, 30mm-55mm, 17kg approx
- 230 x 600mm, 30-50mm, 11.5kg approx
- 375 x 600mm, 30mm-55mm, 21kg approx
- 450 x 600mm, 40-65mm, 33kg approx

Pier Caps

- Available in Light Grey, Buff and Dark Grey colours.
- 370 x 370mm, 11kg approx
- 530 x 530mm, 39kg Approx

Flat

- 230 x 600mm, 50mm, 13kg approx
- 300 x 600mm, 50mm, 20.5kg approx
- 375 x 600mm, 50mm, 24.5kg approx
- 450 x 600mm, 50mm, 31.5kg approx



Concrete Wall Blocks

Colours - Light Grey, Dark Grey, Buff, Red Sandstone

Size - 440 x 100 x 215mm

Our concrete wall blocks offer an attractive aesthetic that blends well in traditional natural stone areas and is a perfect alternative to facing brick for customers seeking a more distinctive masonry appearance

The split finish, reproducing a traditional stone rock face, is an economic alternative to natural stone.



Porcelain Coping Stones



Hammerstone Beige



Bluestone Natural



Hammerstone Grey

Our porcelain coping stones are manufactured from high quality materials and designed to be used on top of walls, piers and masonry. As porcelain is a virtually non porous material they are ideally suited to use on a wall as they keep water ingress to a minimum. The non porous nature of porcelain also help prevent against staining meaning the coping will keep its original colour and be low maintenance throughout its lifetime. Our porcelain copes are fully tested for frost resistance, water absorption, chemical resistance and stain resistance.

Drip Checks are engineered into both side of the coping stones 20mm from the edge. These drip checks prevent water running under the coping stone and onto the face of the wall.



Our porcelain coping stones are surprisingly cost effective so please contact us for more information on pricing.

Free samples are available upon request to confirm colour and suitability

Thickness: 20mm

Width: 150mm, 200mm, 300mm, 400mm

Length 600mm

Drip Checks: Both sides 20mm from edges

Weight:

150mm = 4kg each

200mm = 5.4kg each

300mm = 8kg each

400mm = 10.7kg each

Important Notes

As the rounded edge of the coping is created by hand after the porcelain has been manufactured there may be a slight curing line on one side of the cope . Please take this into consideration when installing so they match as well as possible.

Porcelain coping stones must be installed with an SBR bond bridge when laying in mortar. Please see laying guide for more information.

Porcelain coping stones are suitable for use with our coping stone adhesive as well as traditional mortar.

Pointing can be completed with mortar or an external grade grout.

Porcelain Pier Caps

Matching porcelain pillar/ pier caps are available in bespoke sizes up to 600 x 600mm.

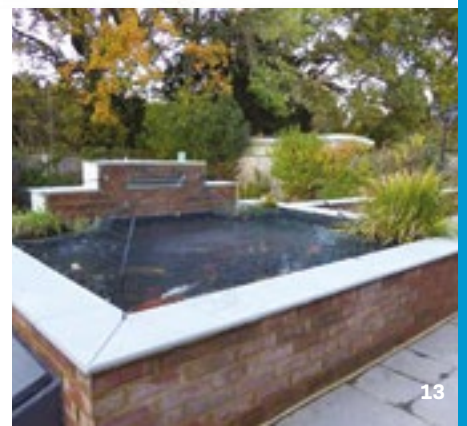

Granite Coping Stones and Pier Caps

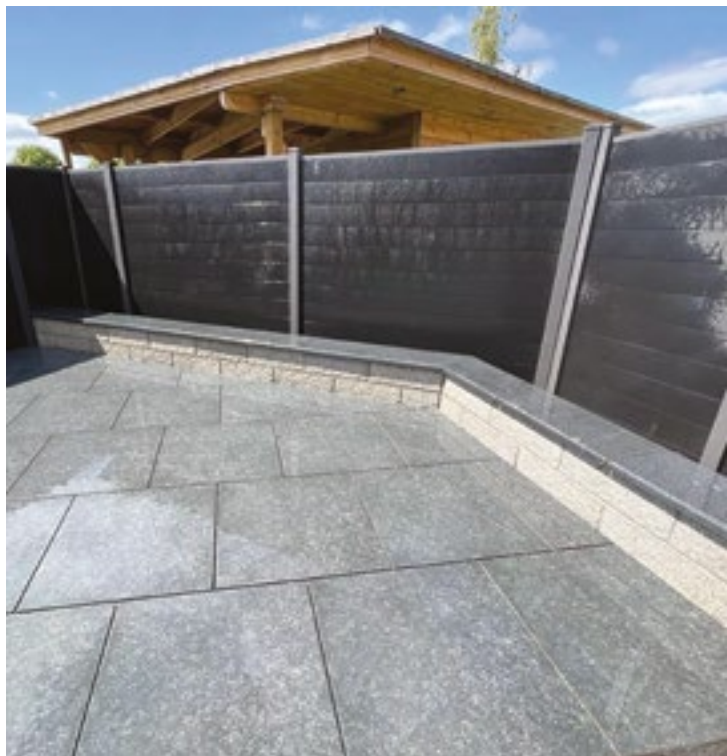

Introducing our exquisite Granite Coping Stones & Pier Caps, the perfect finishing touch for your outdoor spaces. Crafted with precision and elegance, these stones add a touch of sophistication while offering practical functionality. Designed to enhance the appearance and durability of walls, garden borders, and pool edges, our Granite Coping Stones & Pier Caps are the epitome of timeless beauty.

Made from high-quality granite, renowned for its strength and longevity, these stones are built to withstand the elements and retain their beauty for years to come. The natural variations and unique colour patterns of granite add a sense of luxury and character to any landscape design, making it a popular choice among homeowners, architects, and landscapers.

With their smooth and polished surface, our Granite Coping Stones & Pier Caps create a seamless transition between different levels of your outdoor areas. They provide a safe and comfortable edge to sit or lean on, enhancing the functionality and aesthetics of your space. Whether you're enjoying a poolside gathering, lounging in your garden, or simply admiring the view, these coping stones offer a stylish and secure boundary.

Installation is a breeze with our precisely cut and shaped coping stones. Their consistent dimensions and easy-to-handle weight make them ideal for DIY enthusiasts and professionals alike. You can choose from various sizes to suit your specific design requirements, ensuring a seamless integration with existing architectural elements.

In addition to their visual appeal, our Granite Coping Stones are low maintenance and highly resistant to stains, weathering, and fading. They require minimal cleaning and retain their original beauty with little effort, giving you more time to relax and enjoy your outdoor living space.

Colour options: Charcoal Black, Dolomite Grey, Rosa White, Silver Grey

Coping Stones Sizes: 175 x 600mm x 30mm
300 x 600mm x 30mm
375 x 600mm x 30mm

Pier Caps Sizes: 370 x 370mm x 30mm
530 x 530mm x 30mm





Coping Stone Accessories



Coping Stone fasteners

Castle coping stone brackets & fasteners are suitable for mechanically fixing the castle range of concrete coping stones on to horizontal surfaces

Supplied in packs of 10 including fasteners.

Bracket: 30x30mm stainless steel with stainless steel pin

Screws: 5x35mm stainless steel screws

Plugs: Duo 8 plugs

Coping stones must be drilled on site prior to installation. Please see install guide for more information.

Pigment Pots

Pigment pots contain the same pigment used in the manufacture of our coping stones and allow the pointing/mortar to be colour matched.

Supplied in pots of 200 grams.

Simply add the powder to your mortar/pointing mix at 5% weight of cement.

Example – If your mix contains 1kg cement then add 50 grams of pigment to the mix.



Coping Stone Adhesive

Castle coping stone adhesive is a 2 part Polyurethane adhesive that is ideally suited to the installation or replacement of coping stones on garden and parapet walls. Simply mix all of part A and Part B together until the colour is consistent and apply with a notched trowel or by buttering the back of the coping stone.

Please allow 24 hours for curing and wear gloves when applying the adhesive.

Safety data sheet is available for download for more health and safety information.

Coverage 3m² approx



Castle Porcelain Paving

Castle Porcelain Tiles are manufactured and designed to replicate the aesthetics of natural stone, wood and marble without the maintenance issues associated with these products.

Our Porcelain products are manufactured using the finest materials, machinery and techniques to ensure all our tiles are of the highest quality. As our porcelain products are almost completely non porous they are very easy to clean and require little maintenance. All our surface finishes have been tested for slip resistance giving excellent results.

Extra20 tiles are “full bodied” single piece porcelain slabs, squared and rectified with 20 mm thickness. Suitable for outdoor use with a variety of installation methods. We also offer a range of Extra 20 edge, corner and trims to accommodate most applications.

Compact20 is a range of porcelain tiles available in a smaller 300 x 300 x 20mm size, making them very easy to handle on balcony and roofing projects and potentially offering significant savings when cutting at the edges of intricate areas. Compact 20 can either be laid on our supports and pedestals or bonded using PU adhesive for flat roof and balcony projects.

Contract20 is a range of vitrified porcelain tiles with a capped surface finish. These tiles provide a more cost effective solution than our porcelain tiles, while still offering an attractive, tough and non porous paver that is resistant to surface abrasion. Contract20 are suitable for outdoor use with a variety of installation methods.

Extra 20 Porcelain

Extra 20 Porcelain Stoneware are single piece porcelain slabs at 20mm thick. Manufactured using the finest materials, techniques and machinery these full bodied porcelain slabs are extremely hard wearing, dimensionally accurate, strong, light weight and aesthetically pleasing. We also offer a range of edges, corners and trims to accommodate most applications.

Extra 20 offers several installation methods depending on user requirements. Raised installation using our range of support pedestals can be used outdoors on balconies, flat roofs and any other area that requires a gap for drainage or access under the paving.

Installation loose laid onto gravel is also possible on

decorative and low trafficked areas. This method offers quick installation where slabs can be removed at any time.

High trafficked areas and areas where vehicles may be present will require installation using an external grade, flexible, fully bedded adhesive. When using this method the gaps can also be grouted if required. Bedding the tiles in external adhesive is not suitable for use on flat roofs or balconies as it may not be compatible with the waterproofing membrane.

We offer a range of internal and external adhesives and grouts that are suitable for use with our range of tiles.

Surface Finish, Colour & Sizes Available

Trendy Black: 600 x 600, 600 x 1200

Silver Grey: 600 x 600, 600 x 1200

Sandy White: 600 x 600

Classico Contro: 600 x 600

Sahara, 900 x 600

Gardena, 800 x 800

Gris, 900 x 600

Graustein: 600 x 600 , 600 x 1200

Coke: 600 x 600, 450 x 900

Beola Bianca: 600 x 600

Urban Grey: 600 x 600, 600 x 1200

White Quartz: 600 x 600

Silver Contro: 600 x 600

Cinder: 600 x 600, 300 x 1200

Noce: 600 x 600, 300 x 1200

Pierre Bleu: 600 x 600



Trendy Black



Silver Grey



Sandy White



Classico Contro



Sahara



Gardena



Gris



Coke



Graustein



Beola Bianca



Urban Grey



Silver Contro



Cinder

















Noce



Pierre Bleu

Lay using our range of adjustable and fixed height pedestals and supports. See pages 22 to 30 for details. Please refer to our website or call and speak to an adviser for further advice on laying.

Technical Information

TECHNICAL CHARACTERISTIC CARACTÉRISTIQUE TECHNIQUE	NORMA NORME/ NORM	AVERAGE VALUE * VALEUR * MOYEN * DURCHSCHNITTWERTE *		
 Dimensione - Size Dimension - Abmessungen -	ISO 10545-2	Conforme - In accordance Conforme - Erfüllt		
 Absorbimento d'acqua* - Water absorption* Absorption d'eau* - Wasseraufnahme**	ISO 10545-3	0,95%		
	ASTM C373-88 C3061	Conforme - In accordance Conforme - Erfüllt		
 Resistenza alla flessione* - Bending strength* Résistance à la flexion* - Biegezugfestigkeit*	ISO 10545-4	Non applicabile a piastrelle con una forza di rottura Not applicable to tiles with a breaking strength N'est pas applicable aux carreaux avec une charge de rupture Nicht anwendbar bei Fliesen mit einer Bruchlast		
 Sforzo di rottura (SI) - Breaking strength Charge de rupture - Bruchlast -	ISO 10545-4	≥ 10.000 N		
 Resistenza all'abrasione profonda* - Deep scratch resistance* Résistance à l'abrasion profonde* - Widerstand gegen Tiefverschleiß*	ISO 10545-4	≤ 145 mm ³		
 Coefficiente di dilatazione termica lineare* - Thermal linear expansion coefficient* Coefficient de dilatation thermique linéaire* - Koeffizient der linearen thermischen Dehnung*	ISO 10545-8	≈ 7 (10 ⁻⁶) °C ⁻¹		
 Resistenza agli sbalzi termici* - Thermal shock resistance* Résistance aux écarts de température* - Temperaturwechsel Beständigkeit*	ISO 10545-9	Resistente - Resistant Résistante - Beständig		
 Dilatazione all'umidità* - Expansion in humidity* Dilatation à l'humidité* - Feuchtekoeffizientausdehnung*	ISO 10545-10	≤ 0,1 (mm/m)		
 Resistenza al gelo* - Frost resistance* Résistance au gel* - Frostbeständigkeit*	ISO 10545-12	Resistente - Resistant Résistante - Beständig		
 Resistenza all'attacco chimico* - Resistance to chemical attack* Résistance à l'attaque chimique* - Beständigkeit gegen Chemikalien*	ISO 10545-13	Resistente - Resistant Résistante - Beständig - Crocktest		
 Carico statico - Static load Charge statique - Statische Last	EN 12625	40x40-75x75	40x120	
		Centre - Centre Au centre - Mitte	KN-6,0	KN-5,0
		Centre late - Side centre Au centre latéralement - Mitte Seite	KN-5,5	KN-4,0
		Diagonale - Diagonal En diagonale - Diagonal	KN-6,0	KN-7,0
 Classe di carico di rottura*** - Breaking load class*** Classe de charge de rupture*** - Bruchlastklasse***	EN 1239	U11*** T11***		
 Resistenza alle macchie** - Resistance to stains* Résistance aux taches** - Fleckenbeständigkeit*	ISO 10545-14	Pulibile - Cleanable Nettoyable - Leicht zu reinigen		
 Resistenza allo scivolamento** - Slip resistance** Résistance au glissement** - Rutschhemmende Eigenschaften**	DIN 51130-53997	R11 A+B+C Other colours		
	ASTM C1029	C.O.F. WET	≥ 0,70	
		C.O.F. DRY	≥ 0,70	
 Spessore nominale - Nominal Thickness Épaisseur nominale - Nennstärke		20 mm		

If the application of the 20mm slabs foresees the porcelain product used in structural installations, the project engineer and/or customer must carefully assess the project requirements with regard to the technical specifications of the slabs. To prevent the risk of damage or injury, the manufacturer recommends: With regard to a raised floor installation a porcelain slab may fracture on impact if a heavy object falls on it from any significant height. Therefore the manufacturer recommends to check the specific intended use before starting the installation. In certain conditions, reinforcing must be applied on the back of the slabs (double glass fibre net or a galvanized steel sheet) supplied and applied by the manufacturer; With reference to any dry installation system of flooring above the ground level, the manufacturer recommends to comply with local regulations and conditions of use with regard to wind, load, load bearing, seismic events, etc. Failure to comply with these recommendations may lead to improper use of

the product and could cause serious damage or injury. Outdoor pavings installed unglued above the ground level are subject to the action of the wind, with the risk, in some cases, of becoming airborne. The manufacturer recommends to require the assistance of a qualified professional in order to check the suitability of the installation system above the ground adopted, in accordance with the local laws and regulations and the conditions of use. Failure to do so could result in serious injury or property damage. A porcelain slab installed on a raised pedestal system may fracture on impact if a heavy object is dropped onto it from a height, with a risk of injury to anyone standing or walking on such slab. Failure to adhere to the manufacturer's instructions for installation of slabs on raised pedestal systems may result in serious injury.



Rounded and half rounded tiles are available. Please enquire for further details.

Compact 20 Porcelain

Product Description

Compact 20 porcelain is a range of extremely durable, porcelain, outdoor tiles that will retain their beautiful colours for years. Even in the most extreme weather conditions. Better yet, they require virtually no maintenance.

Manufactured from high quality porcelain, Compact 20 provides the tested strength and requirements to be laid either on our supports and pedestals or bonded using PU adhesive for flat roof and balcony projects.

Installation can also be achieved on garden patio areas using a more traditional mortar bed with SBR bond bridge.

Please download our installation guide for more information on laying Compact 20 Porcelain.

At only 300 x 300 x 20mm Compact 20 can accommodate very low threshold areas and imposes a load of only 46kg per m².

Due to the smaller dimensions of Compact 20 they are very easy to handle on balcony and roofing projects and can offer significant savings when cutting at the edges of intricate areas.

As porcelain is virtually non porous it requires very little maintenance as any dirt can only sit on top of the tile. Compact 20 is also resistant to staining from dirt, debris, chemicals and most household goods. Our porcelain tiles are also UV stable, so you can be sure the colour and finish will remain as beautiful as the day they were installed.

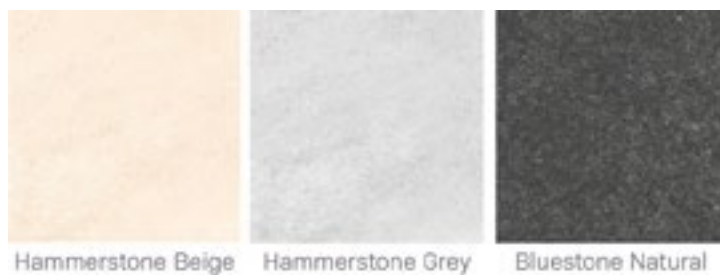

Range

Hammerstone Beige - 300 x 300 x 20mm
Hammerstone Grey - 300 x 300 x 20mm
Bluestone Natural - 300 x 300 x 20mm

Technical information

Dimension Tolerance: EN ISO 10545-2, $\pm 0,1\%$

Thickness tolerance: EN ISO 10545-2, $\pm 3,0$

Straightness of sides: EN ISO 10545-2, $\pm 0,1\%$

Rectangularity: EN ISO 10545-2, $\pm 0,1\%$

Colour Difference: EN ISO 10545-16, No Change

Water Absorption: EN ISO 10545-3, $\pm 0,1\%$

Modulus Rupture: EN ISO 10545-4, MIN 40 N/mm³

Abrasion resistance: EN ISO 10545-7, Min Class 4-5

MOH's hardness: EN 101, Min Class 6-11

Frost resistance: EN ISO 10545-12, No damage

Thermal shock resistance: EN ISO 10545-9, No damage

Moisture expansion: EN ISO 10545-10, Nil

Crazing resistance: EN ISO 10545-1, Min 10 Cycle

Chemical resistance: EN ISO 10545-13, No damage

Stain resistance: EN ISO 10545-14, Resistance

Fire resistance: NA, Fire proof

Lead & cadmium given off by glazed tiles:

EN ISO 10545-7, Does not yield pb & cd

Porcelain tiles are also UV stable, so you can be sure the colour and finish will remain as beautiful as the day they were installed.



Lay using our range of adjustable and fixed height pedestals and supports. See pages 22 to 30 for details. Please refer to our website or call and speak to an adviser for further advice on laying.



Contract 20 Porcelain

Product Description

Contract 20 is a range of vitrified porcelain tiles with a capped surface finish. These are suitable for use on garden patios, balconies, flat roofs and terraces. Contract 20 can be laid in mortar with an SBR bond bridge or using our range of supports & pedestals, refer to our website for further details on laying.

The Contract 20 range provides a more cost effective solution than our full bodied porcelain tiles, while still offering a paver that is resistant to surface abrasion.

All Contract 20 tiles have a slip resistant surface finish and test at R11 making them ideal for outdoor paved areas. Come rain, frost or heat, our Contract 20 tiles take on the elements with ease, season after season, keeping their beauty intact. This 20mm thick, super resilient tile works for indoor as well as outdoor spaces. Contract 20 comes in a popular size that fits any environment just as nicely as it fits your budget.

Choose from a delightful range of designs and finishes.

Note: Always order the required quantity plus at least 5% wastage.

			
Bluestone Natural 300 x 300 x 20 600 x 600 x 20	Country Gris 600 x 600 x 20 900 x 600 x 20	Hammerstone Grey 300 x 300 x 20 600 x 600 x 20 900 x 600 x 20	Hammerstone Beige 300 x 300 x 20 600 x 600 x 20 900 x 600 x 20
			
Flint Rock 600 x 600 x 20	Golden Stone 600 x 600 x 20	Slate Rock 900 x 600 x 20	Country Style 900 x 600 x 20
			
Grey Rock 900 x 600 x 20	Quartz White 900 x 600 x 20	Country Anthracite 900 x 600 x 20	



Technical Description

Dimension Tolerance: EN ISO I0545-2, $\pm 0,1\%$
Thickness tolerance: EN ISO I0545-2, $\pm 3,0$
Straightness of sides: EN ISO I0545-2, $\pm 0,1\%$
Rectangularity: EN ISO I0545-2, $\pm 0,1\%$
Colour Difference: EN ISO I0545-16, No Change
Water Absorption: EN ISO I0545-3, $\pm 0,1\%$
Modulus Rupture: EN ISO I0545-4, MIN 40 N/mm³
Abrasion resistance: EN ISO I0545-7, Min Class 4-5
MOH's hardness: EN 101, Min Class 6-11
Frost resistance: EN ISO I0545-12, No damage

Thermal shock resistance: EN ISO I0545-9, No damage
Moisture expansion: EN ISO I0545-10, Nil
Crazing resistance: EN ISO I0545-1, Min 10 Cycle
Chemical resistance: EN ISO I0545-13, No damage
Stain resistance: EN ISO I0545-14, Resistance
Fire resistance: NA, Fire proof
Lead & cadmium given off by glazed tiles:
 EN ISO I0545-7, Does no yield pb & cd

Porcelain tiles are also UV stable, so you can be sure the colour and finish will remain as beautiful as the day they were installed.

Lay using our range of adjustable and fixed height pedestals and supports. See pages 22 to 30 for details. Please refer to our website or call and speak to an adviser for further advice on laying.



Porcelain Border Edge Tiles

Our porcelain border tiles can be used to create a contrasting edge on patios and walkways. Available in Hammerstone Grey and Bluestone colours. At 150x900x20mm they are a perfect size for this application.



Bluestone

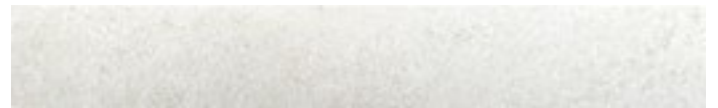

Hammerstone Grey

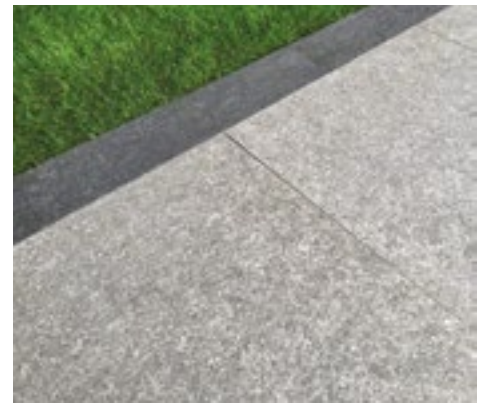

Porcelain Paving Accessories – Grout & Primer

UltraTile ProPave Primer is a polymer modified cementitious slurry primer specifically formulated to provide exceptional bond between all types of stone surfaces. The product is suitable for application on driveways and patios.

Specifically formulated for Porcelain and Natural Stone. Provides exceptional bond and durability. Simply mix with water. Quick and easy roller brush application. Enhances lifetime performance of paved area. Size: 17kg bucket

UltraTile ProPave Grout is a high specification, decorative, brush-in external tile jointing solution, suitable for use with granite, porcelain and other premium quality natural stone. The product is available in 4 bespoke colours – Cosmic Black, Natural Cashmere, Storm Grey and Pebble Grey – the perfect choice for a seamless transition from tiles inside, to outside living spaces.

- Ideal for use with 20mm porcelain tiles
- Colour shield technology for a vibrant finish
- Can be used in all weather
- Walk on in 24-48 hours
- No waste, left over material can be re-used
- Fills joints from 3-20mm
- Size: 15kg bucket



Paving Support Pads



Plastic Stackable Paving Supports & Shims

Plastic support pads are designed for use with paving slabs on balconies, flat roofs and terraces. Manufactured from injection moulded high density polypropylene. They are available in two standard sizes, 10mm and 15mm thick.

All our plastic supports come with 3mm lugs as standard. 10 & 15mm supports can be supplied with 5mm lugs if required on special request.

They are designed to stack on top of one another, where installers wish to increase the height of the cavity at intervals – to work around gutter and service pipes, for example. Although lightweight, they are very tough, with a weight tolerance of 400kg per support pad.

By suspending the paving, they allow water to run away from the deck underneath. They also help to prevent the build-up of dirt and other material between the slabs.

This system eliminates ponding on the upper surface of the roof or balcony paving.

1.5mm levelling shims are also available to allow for undulations in the roof surface and minor variation in paving slab thickness.

Size: 10mm & 15mm
Injection Moulded Polypropylene
Bearing Capacity: 400kg



Heavy Duty 16mm Plastic Stackable Paving Support

The 16mm HD Support has a 176mm diameter base with a very strong lattice design. These supports can be used in areas that have higher than normal loads.

Load tested to 750kg

HD 2mm levelling discs are also available for areas with minor undulation or to adjust for minor paver thickness variation.

Supplied with pre positioned 3mm spacer lugs however 5mm spacer lugs can be added if required on special request.

As the HD 16mm supports are stackable to a height of three high, they can achieve a total height of 48mm.

When laying at edges and corners the supports can simply be broken into halves and quarters for easy installation.

More information on installation can be found in our installation guide download.

Size: 16mm, 176mm Diameter

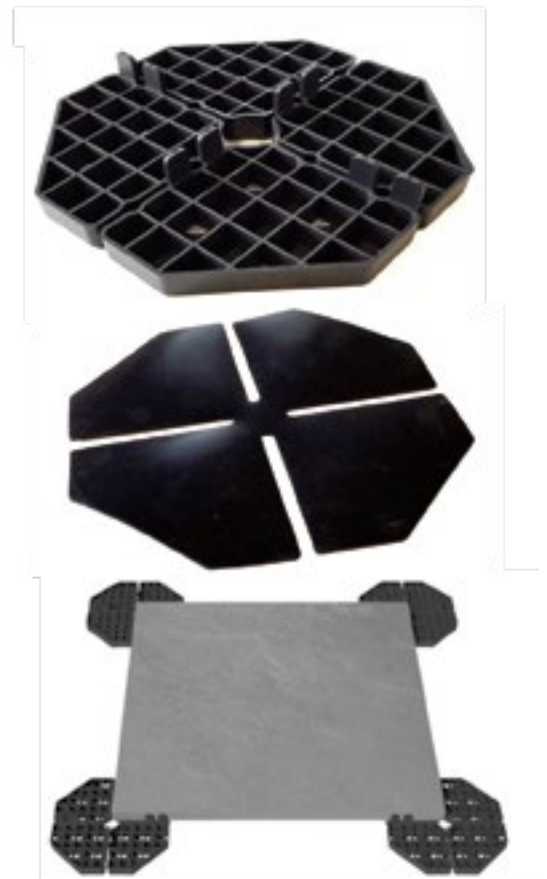

8mm Rubber Supports DDP00

DDP00 rubber supports are designed for laying paving on flat roofs, balconies and terraces. When installed they support the pavers 8mm above the waterproofing, creating a free draining area.

The rubber composition of the support helps reduce the likelihood of damage to the waterproofing.

Supplied with integral 3mm spacer lugs. 5mm spacer lugs can be supplied for fitment on special request. Compatible with SH100 1.5mm rubber shims.

Please see our guide to installation for more information on how to use the DDP00 rubber supports.

Size: 8mm, 105mm dia.



ASLON Rubber Support Pads

ASLON Paving Support Pads are a versatile low cost option for supporting paving on flat roofs and balconies. Manufactured from recycled rubber granulate they are also one of the very few environmentally friendly options available.

ASLON support pads also have the unique facility to be able to interlock slabs together but not to the waterproofing to provide additional stability at open edges and areas affected by high wind uplift. Edging the layout when using ASLON pads is also straight forward and helps to prevent wind uplift and debris from getting under the layout.

At only 10mm thick ASLON pads are ideal for areas that have low threshold issues. Used with our 300 x 300 Promenade Slabs they give an overall thickness of only 30mm.

Size: 100x100x10mm, 200x200x10mm, 3mm X Spacer

Other sizes available special order.

Recycled SBR Rubber

Excellent Edge Restraint

Low Noise Transfer



DD 2mm Plastic Support

Our 2mm plastic support is perfect for projects that have low threshold height restrictions.

This simple easy to use design allows paving to be laid in areas with threshold heights as low as 22mm.

The 2mm support can also be used with our 1.5mm rubber shims for fine adjustment.

Available in a black or clear finish.

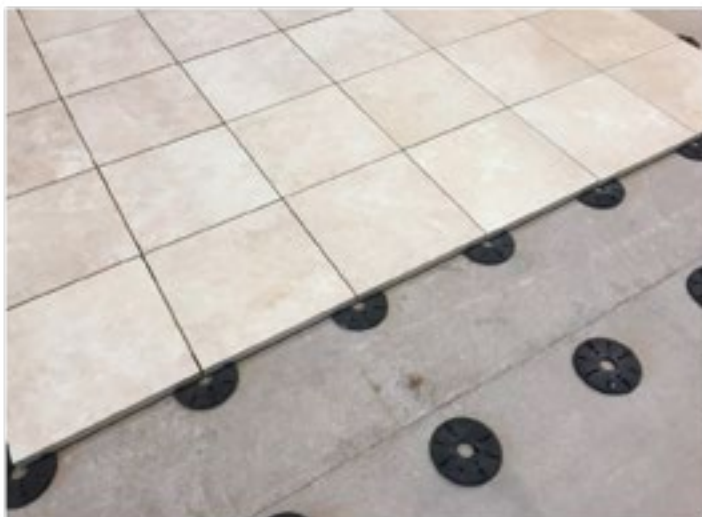



Adjustable Pedestals



Where to use:

- Terraces
- Flat Roofs
- Balconies
- Green Roofs
- Walkways
- Urban Fountains
- Pool Surrounds
- Decking
- Installations
- Temporary Floors



Advantages of Using Adjustable Pedestals



FAST WATER DRAINAGE

The gaps created between the pavers allow water to drain onto the waterproofing or base beneath. This keeps the walking surface free from ponding water. The reduction in dampness reduces the risk of moss and algae growth, which can adversely impact slip resistance.



ADDITIONAL THERMAL INSULATION

The pedestal system gives increased thermal insulation over the waterproofing. The gaps between each paver also allow for ventilation so that rain water can evaporate if water has ponded underneath.

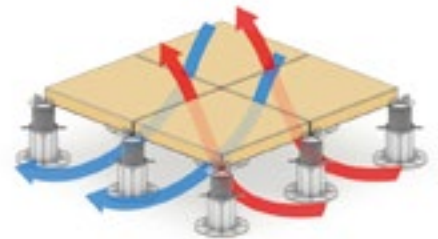

ABILITY TO HIDE PIPES AND EQUIPMENT

Having pavers raised on our pedestals allow pipes, cables and equipment to be concealed in the void between the base and the paving. These hidden items can be accessed easily by simply removing a paver.

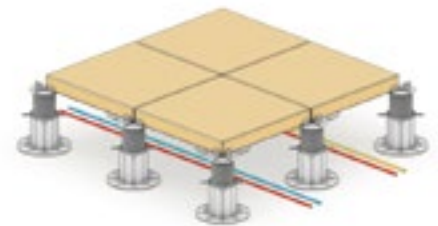

LIGHT WEIGHT

As DD Pedestals are manufactured in a strong but lightweight design the overall weight of the system is relatively light in comparison to traditional paving methods.



LEVEL SURFACE

Level surfaces can be achieved easily using DD Pedestals. The supports can be adjusted in height and optional slope correction heads are available when laying on sloped surfaces.



PROTECTS WATERPROOFING

When paving a flat roof, balcony or terrace, DD Pedestals allow the paving to be raised above the waterproofing removing the risk of damage that comes from traditional paving methods.



urban fountains



pool surrounds



steel constructions

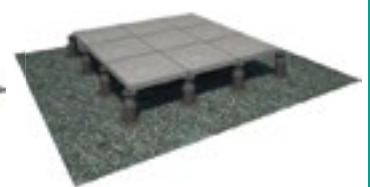

roof terraces

Standard Series



DDP 01
30-45mm

DDP 02
45-70mm

DDP 03
70-120mm

DDP 04
120-220mm

DS
+100mm

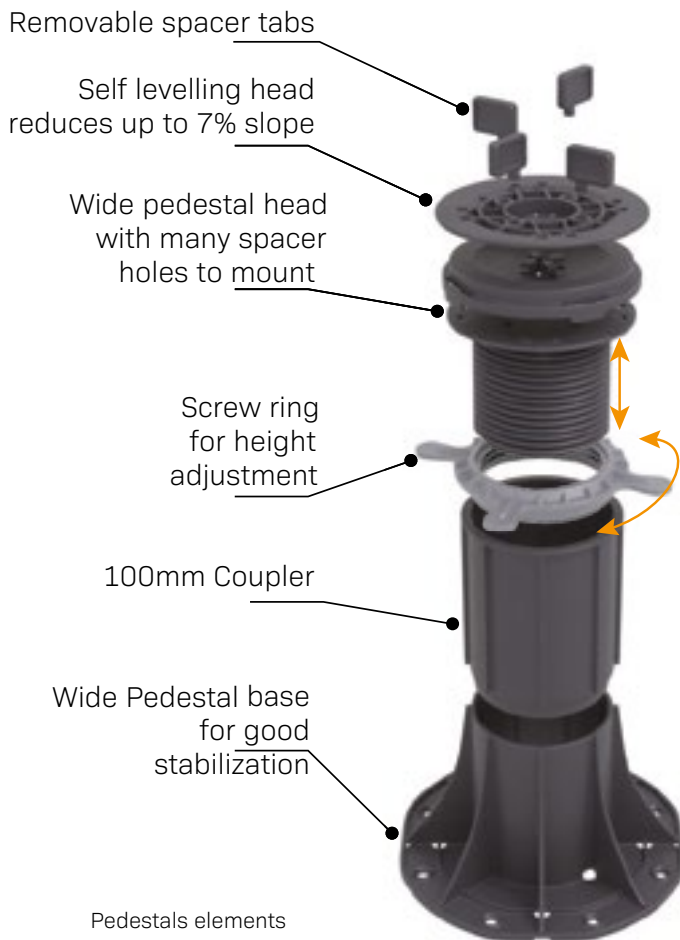

The DD adjustable Pedestal system is an innovative solution for external raised and ventilated balconies, flat roofs and terraces. Adjustable pedestals help prevent water laying on the paving surface and allows for easy access to the surface below.

ADVANTAGES:

- Self levelling of slopes up to 7%
- Height adjustment from 30 – 520 mm
- Height adjustment possible with paving in place
- 221 cm² base surface
- Temperature tested from -40 deg C to 120 deg C
- External weathering and UV resistant.



Adjustable Pedestals DDP are ecological and are made from material which is recyclable



Product is resistant to high and low temperatures

SELF LEVELLING SLOPES

Self levelling head automatically reduces the slope of the surface up to 7%.

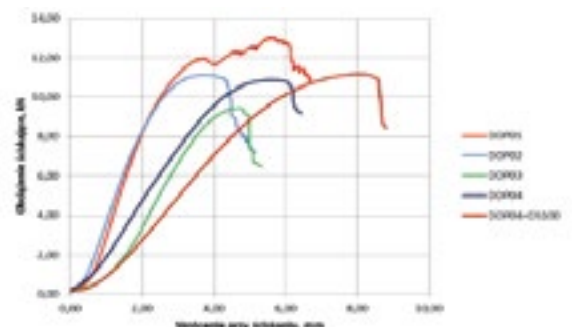
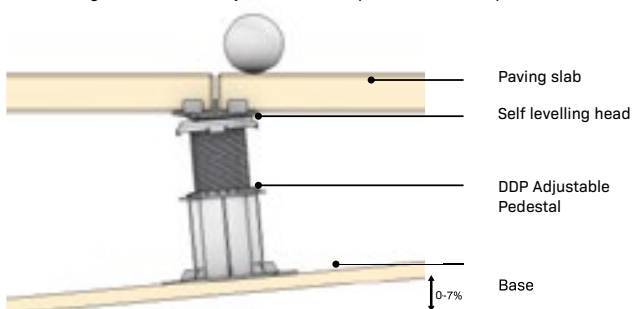

Maximum load bearing weight is 1000 kg per 1 pedestal. Safety factor is 50% destroying force.

Standard Series Accessories

NEW DECKING ADAPTER



COUPLER DS 100mm

Coupler which enhances regulation height by additional 100mm



SPACER TAB

Gap width 3mm

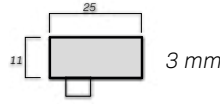

Regulation Shim SH 1.5mm

1.5mm shims are used to adjust for variation in slab thickness and for noise reduction

PEDESTALS PLACEMENT

Pedestals placement on exemplary terrace.

SPACER TABS PLACEMENT

Head of the pedestal allows wide variety placement for every kind of terrace surface

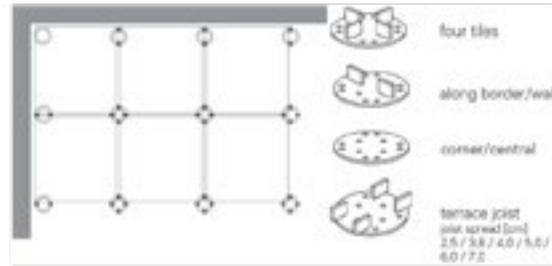

Tile Upstand Unit

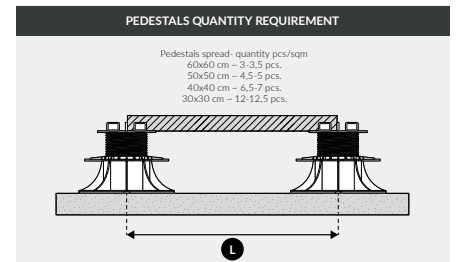
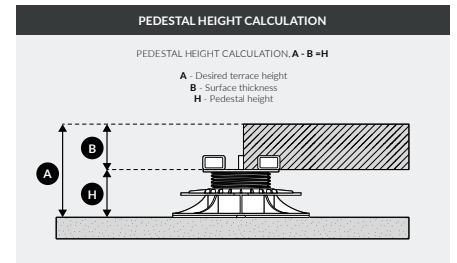

Technical Support

We are happy to help Architects, merchants, contractors and DIY installers when it comes to technical questions in relation to DD Pedestals. We can also provide detailed CAD drawings which are ready to use if required. If you have any technical questions or require CAD drawings please contact us.



Wall Edge Accessory

Spiral Adjustable Paving Support



10-17mm



17-30mm

Adjustable 10-17mm & 17-30mm spiral pedestals designed for use in low threshold areas on flat roofs and balconies. These can be used alongside our DDP range of pedestals to help overcome threshold issues at the top of the drainage fall. Supplied with 3mm spacing lugs as standard.

Adjustment is achieved by simply twisting the support to go up or down. This support is available in fixed head only.

1.5mm noise/leveling shims can also be used with this support type.

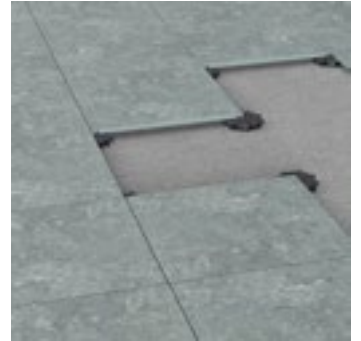

Raptor Decking Supports & Pedestals



Raptor Decking pedestals are specially designed for use with decking joists and beams. This low cost decking pedestal allows the decking joists to be raised and levelled as required. These unique pedestals are 100% designed for the decking industry.

Decking pedestals should not only be durable but also resistant to external weather conditions. Installation of pedestals should also be as easy as possible. This is important especially when installation is completed by a DIY user. With this in mind, we used our many years of experience to create the Raptor decking pedestal series.

The Raptor decking support allows users to accurately adjust the decking height and slope at minimal cost and labour time.

All Raptor decking pedestals have technical openings which allow rainwater flow.

Suitable for use with timber, aluminium and composite joists.

Tested up to 1000kg per pedestal.

Sizes: 15-245mm



DD Maxi Adjustable Pedestals



Maxi 1.5mm Rubber Shim



Maxi Joist Adapter



Maxi Adjustment Key



Maxi Slope Correction Head



Maxi 250-550mm



Maxi 150-350mm

The new series of DD Maxi adjustable pedestals are the answer for high demand projects where no compromise in quality and durability of the flat roof, balcony or patio is of the highest importance. The adjustable Maxi Pedestal series can be used with most external raised decks and patios. With height level up to 550mm there is no limit with making a terrace on adjustable pedestals. Bigger, better, stronger are words which best describe the Maxi pedestals series.

Maxi adjustable pedestals are manufactured and tested to provide higher loading capacity than the standard DD pedestal range.

MAX series benefits from:

- Height regulation ring
- Optional Rubber shims 1,5 MM
- Gap spacer 3 or 5 MM
- Optional Decking joist adapter
- Base diameter 200 mm
- Head diameter 140 mm
- 1200 kg weight resistance
- Optional Self leveling head 0-5%
- Optional Wind uplift lock system
- Optional Height regulation key



A1 Fire Rated ALU Adjustable Pedestals

Our uniquely designed A1 Euroclass fire rated ALU pedestals are a cost effective option without the need to sacrifice quality, strength or functionality. Designed for use on high rise buildings where non combustible materials are required.

There are no non metallic components within the pedestal units meaning they achieve a class A1 rating as per PN-EN 13501-1, BS-EN 13501-1 .

The pedestals create a 3mm gap between pavers as standard and they can also be used with a variety of aluminum joists by simply placing the joists between the spacing lugs.

All sizes are supplied with self leveling heads that offer up to 6% slope correction. ALU pedestals are supplied part assembled which leaves only the head piece to be connected to the base and adjusted for height. As the pedestals are supplied part assembled they offer time savings during installation.

ALU pedestals are also resistant to mechanical damage, cracking and chemical agents.

Size: 40 - 200mm

EUROCLASS A1, PN-EN 13501-1, BS-EN 13501-1







Castleflex Rubber Tiles

Castleflex Rubber Promenade Tiles

Castleflex Rubber Promenade Tiles are manufactured from recycled rubber granulate. Installation is made simple with the integrated connector pins meaning there is little or no need for adhesive. Drainage channels on the underside of the tile ensure that water is removed quickly whilst maintaining sufficient load bearing capacity for foot traffic and garden furniture. If in the future the area needs to be extended or a tile needs to be replaced this can be done with ease due to the installation method. Castleflex Rubber Promenade Tiles also have the added benefit of being soft therefore very safe for children and the elderly.



Suitable Surfaces

- Bituminous Felt
- Timber
- Asphalt (with protection board)
- Lead
- EPDM / Rubber
- Single Ply Membranes
- Concrete
- Fibre Glass

- Drainage channels on underside for quick water removal and good weight distribution
- Simple Installation with four integrated connector pins.
- Long Life (Even at below freezing temperatures).
- Reduced danger of injury due to the soft nature of the tiles.
- Noise Deadening and Thermal Insulation.
- Recycled environmentally friendly product.
- Comfortable and safe to walk on.
- Reduced on site labour and equipment.

Dimensions: Length: 500mm; Width: 500mm; Thickness: 30mm

Weight: 20.0 kg per m2 approx; 5.0 kg per tile approx

Composition: Recycled PU bound rubber granulate in a range of colours.

Fire Classification: Efl as per EN 13501-1 & Broof(t1) as per EN13501-1

Insulation Value: Rd 0,15 EN13165; U 3,13 EN6946

Slip Resistance: Dry: 102 Wet: 62 (Low Potential For Slip) EN 1339 Pendulum Test

Safety: 30mm thick = Critical fall height 1metre (Thicker tiles available where greater fall height required) Complies with Safety Standard EN1177

Smoke Classification: S2

Density: 800kg per m3

Water Permeability: 565mm per hour EN 12616



Drainage channels designed to facilitate water flow when laid in brick bond formation.





Castleflex Technical Information

Before laying tiles please ensure that the supporting surface is in good condition, can drain water properly and is compatible with rubber tiles.

We recommend that the tiles are laid in a brick bond formation to ensure good interlocking between tiles. However they can be laid in standard squares where required.

Begin laying the tiles in a corner of the area to be covered. Use the interlocking pins to lock the tiles together. When the first row has been laid check for alignment before proceeding.

Castleflex Rubber Promenade Tiles can be cut easily using a low speed coarse toothed jigsaw, handsaw or craft knife. To ensure straight lines use a straight edge down the section that needs to be cut.

To achieve improved stability we recommend adhering the first and last row of the layout using Castle XP - 2435 PU Adhesive where no edge restraint exists.

Castle XP 2435 adhesive is available in 1 litre bottles with nozzle for application. Adhesive should be applied to the tile taking care not to block the drainage channels. Adhesive should be allowed 24hrs to cure before trafficking.

Loose dirt, dust, foods and other materials can be removed using either a heavy duty vacuum cleaner, soft brush and diluted liquid detergent or pressure washer.

To clean with brush and detergent simply brush the surface with warm water and rinse thoroughly. When using a high pressure washer do not allow the nozzle to get closer than 40cm to the tile. Dirt blaster nozzles should also be avoided. When using a vacuum cleaner please ensure the mechanical brush is soft enough to avoid damage to the tiles.

Due to the recycled nature of the products colour may vary slightly between batches and can wear in areas of high traffic. SBR rubber tiles contain carbon that may leach in certain areas.

Castleflex Ramp Edge Tiles & Trim

Ramp edge tiles are available for applications where a ramped access is required to the layout from adjacent walkways or stairs. Available in 500 x 500mm in all six colours. Ramp edge tiles are also supplied with interlocking pins.

A 25 x 25mm plastic edge trim is available for installation with our rubber tile range. Our edge trim helps prevent debris migrating under the tiles and improves the appearance of visible edges. Available in White, Silver, Grey and Black in 1 metre lengths. Installed by simply sliding under the tiles and bonding with adhesive.

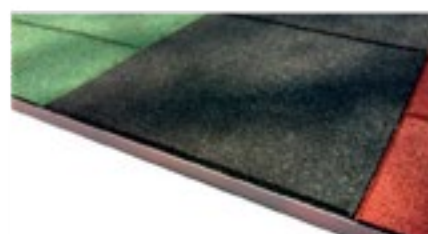
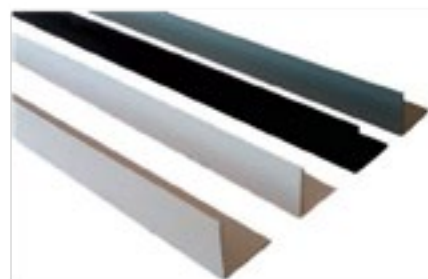
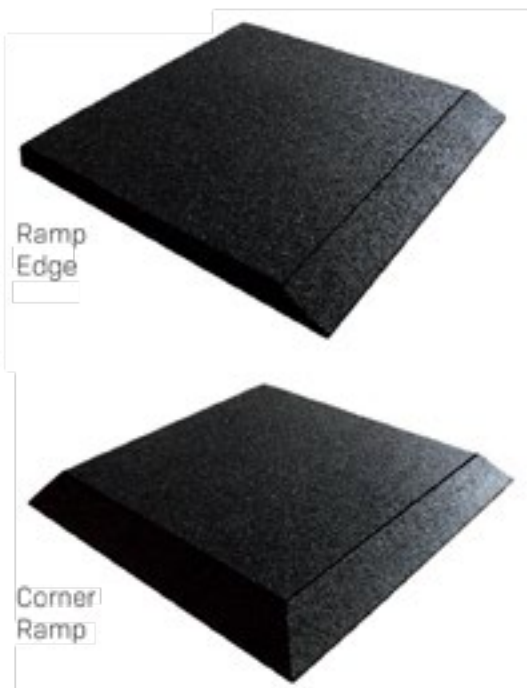

Castleflex EPDM Coated Rubber Tiles

Castleflex EPDM coated rubber tiles are a perfect upgrade on standard Castleflex tiles where Reach compliance is required.

Manufactured from SBR rubber the top layer of colour is coated with EPDM allowing them to be Reach compliant and have increased fire and smoke resistance.

As the tiles are EPDM coated they offer significant savings over our EPDM granulate tiles. However our full EPDM range does have increased choice of colour.

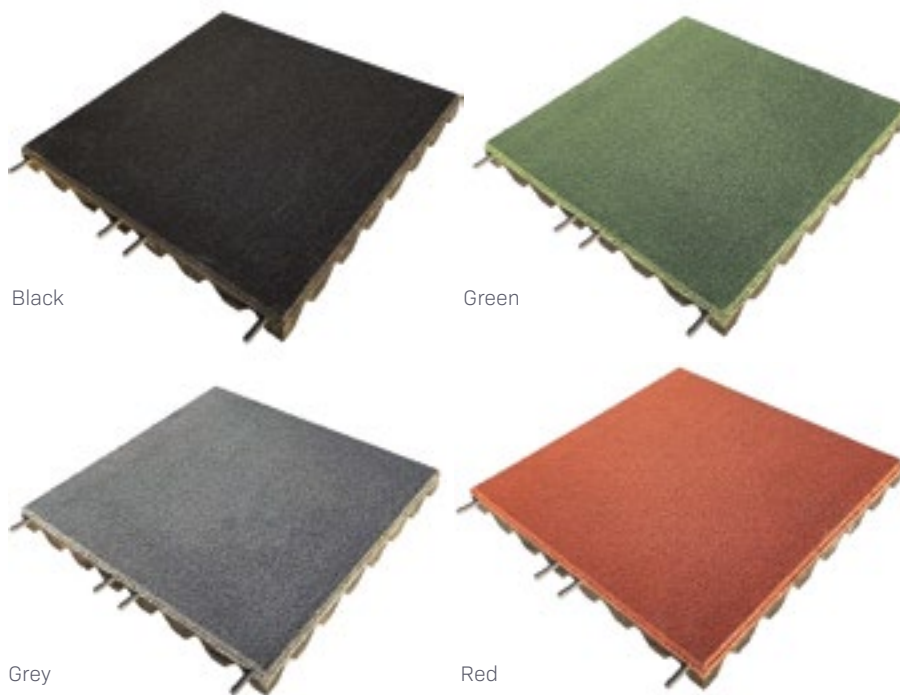

Coated EPDM tile

Material composition: black SBR granulate bound with a PU binding agent and a top layer of approximately 5 mm coated EPDM.

Size: 250 x 500 mm / 500 x 500 mm / 1000 x 1000 mm (1000 x 1000 mm up to 65 mm thickness)

Thickness: 25, 30, 40, 45, 50, 65, 80 and 100 mm

Colours: Black, Red, Green, Grey

Density: 800 kg/m³

Fire resistance: Cfl to EN 13501

Smoke resistance: S1

TÜV: Dflect Coated EPDM tiles are TÜV certified. They meet the Attractions and Playground Apparatus Act EN1177

Size tolerance: width 2% and thickness 5%

Colourfastness: the product is not colourfast and the colour may change due to influences of the weather and walking on the tiles

Quicklime/cement veil: influences of the weather and the quicklime/cement veiling of the surrounding objects could cause a white efflorescence on the tiles and mats

Guarantee: 3 year guarantee for wear-resistance, with the exception of tiles that are used intensively. The guarantee does not apply to colour

Recycling: products are 100% recyclable

Water permeability: 325 mm per hour EN 12616

Insulation value: Rd 0,15 EN13165

U 3,13 EN 6946



Castleflex EPDM Rubber Tiles



Whilst Castleflex tiles are ideal for use on flat roofs and balconies for those who would like something extra special we have the Castleflex EPDM range.

Castleflex EPDM are also 500 x 500 x 30mm (interlocking) with the top surface being manufactured from virgin rubber. As no recycled rubber is used in the top surface of the EPDM range we are able to offer a wider range of colours including our mixed colour options. The EPDM tile has a similar drainage channel design to the Castleflex Tiles.

As the top surface contains only virgin rubber a high quality surface finish is achieved which is long lasting, more UV stable and has better flammability and smoke classification performance.

EPDM is an abbreviation of Ethylene Propylene Diene Monomer. Our EPDM tiles have a top layer as per your colour choice.

Dimensions: Length: 500mm; Width: 500mm; Thickness: 30mm

Weight: 20.0 kg per m² approx; 5.0 kg per tile approx

Composition: PU bound EPDM rubber granulate in a range of colours.

Fire Classification: Cfl based on EN 13501

Insulation Value: Rd 0,15 EN13165; U 3,13 EN6946 Slip

Resistance: Dry: 102 Wet: 62
(Low Potential For Slip)

EN 1339 Pendulum Test

Safety: 30mm thick = Critical fall height 1metre
(Thicker tiles available where greater fall height required)
Complies with Safety Standard EN1177

Smoke Classification: S1

Density: 800kg per m³

Water Permeability: 325mm per hour EN 12616

If colour required is not above please contact us as we can have custom EPDM colours made.



Grassflex

Artificial Grass Topped Rubber Tiles

Artificial grass is occasionally used on flat roof and balcony applications. In most cases consideration is not taken as to how the grass should be bonded to the waterproofing and whether or not the artificial grass can damage the waterproofing.

Grassflex tiles are manufactured with a recycled rubber granulate base that is soft and safe for use on waterproofing membranes. Grassflex tiles are also manufactured with drainage channels on the underside. As the tiles are water permeable up to 250mm per hour (EN 1176) they allow rain water to flow through the tiles and off the waterproofing through the drainage channels on the underside.

Grassflex tiles are also commonly used in display areas and gyms.



500 x 500 x 30mm (Interlocking)



500 x 500 x 25mm

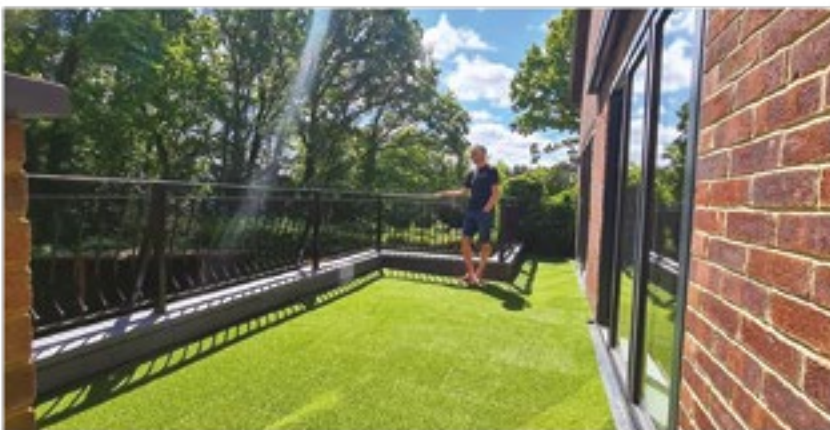

Technical Data

Size: 500 x 500 x 25mm (Bonded);
 1000 x 100 x 25mm (Bonded)
 Size: 500 x 500 x 30mm
 (Interlocking)
 Weight: 25mm: 4.5kg 30mm: 5kg
 Permeable: 250mm per hour



Rubber Roof Walkway Tiles

Roofway Access Walkway Tiles

Roofway is a porous self draining roof matting system which is used on flat roofs to provide safe access for maintenance of rooftop plant.

Manufactured from recycled rubber granulate and with yellow EPDM rubber edges they provide a self draining, slip resistant walkway that clearly identifies safe access areas. As the Yellow edges contain only EPDM rubber they will be resistant to fading or discolouration.

Roofway Tiles are supplied with interlocking pins for installation. When laying Roofway in more exposed locations we recommend adhering them to the roof using our 2435 PU Adhesive for extra stability.

Straight, corner and T piece tiles are available to suit your project. Tiles can easily be cut on site using a craft knife or fine toothed saw.

Dimensions

Length: 1200mm
Width: 600mm
Thickness: 30mm



Weight

20.0 kg per m2 approx
11.5 kg per tile approx

Composition

Recycled PU bound rubber granulate with yellow EPDM rubber edges

Fire Classification

Efl as per EN 13501-1 & Broof(t1) as per EN13501-1

Slip Resistance

Dry: 102 Wet: 62 (Low Potential For Slip)
EN 1339 Pendulum Test

Safety

30mm thick = Critical fall height 1metre (Thicker tiles available where greater fall height required)
Complies with Safety Standard EN1177

Smoke Classification

S2

Density

800kg per m3

Water Permeability

565mm per hour EN 12616





Castlewood Composite Decking





Forest Decking Boards

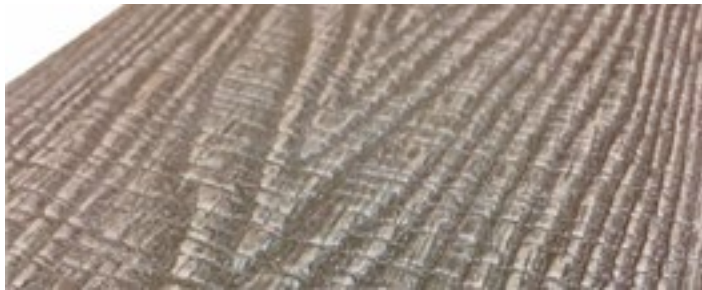

We stock four colours; Wild Brown, Antique Ash, Salt Lake Silver & Ancient Black. All you need to do is choose the perfect colour for your project.

Our decking range is two-sided, each side with its own style. One side has a wood grain texture while the other has a grooved texture. This variety of styling allows for decking designs unique to each project. Pick and mix from the available colours of decking then create unique arrangements when the deck is built.

Technical Information

Board Size: 22 x 145 x 3600mm
 Weight: 19kg Per M2
 Composition: Wood fibres, PVC & Additives
 Side A: Woodgrain
 Side B: Grooved
 Slip Resistance: 45 Wet
 (Low Potential for Slip) BS 7976
 Guarantee: 5 year Limited Warranty

Edge Trim

Edge Trim Dimensions: 50x50x3600mm
 5mm Thick



Castlewood Forest Composite Decking is a timber alternative made of 60% timber content, making it strong and resilient. Furthermore it is waterproof, slip resistant and splinter-free making it safe for children and pets. The product is also eco friendly as a result of using recycled timber and recycled plastic polymer.

Composite WPC decking allows for a more personal appeal than traditional timber. While timber decking allows for a wide choice of wood types, some natural wood costs much more than other wood types. In addition, a lot of work is necessary to maintain and change the look of the timber. This is not necessary with composite wood decking.



Salt Lake Silver



Antique Ash



Ancient Black



Wild Brown

Bullnose Board



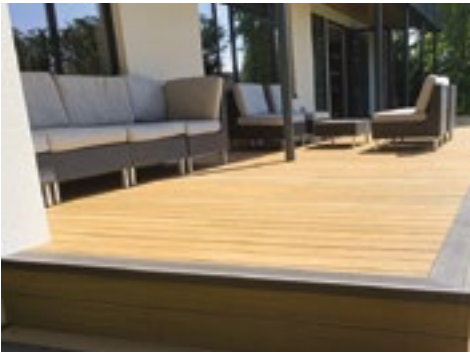

Ultra Guard Decking Boards

Wood Plastic Composite Decking Boards

Castlewood Ultra Guard Composite Decking is one of the most attractive and durable decking boards on the market. Ultra Guard combines the proven strength of high density polythene plastic and wood fibres with an outer shell of polymer that completely encapsulates the board in an impermeable layer of protection from scratches, stains and fading.

Castlewood Ultra Guard decking boards are manufactured from 95 percent recycled materials including clear plastic bottles and reclaimed wood fibres, which are an excellent eco-friendly alternative to wood.

Castlewood Ultra Guard decking boards are backed by one of the most comprehensive warranties in the industry. A 10 year limited transferable warranty for residential applications and a 10 year warranty for commercial applications. (Terms & Conditions Apply).

The boards have a natural/woodgrain finish on one side and a grooved finish on the other to suit all installation requirements

Colours: Oak, Teak, Silver Grey, Ebony & Antique

Dimensions: 138 x 22.5 x 3660mm

Composition: High Density Polythene Plastic/Wood Fibre

Guarantee Residential: 10 Years (Terms & Conditions Apply)

Guarantee Commercial: 10 Years (Terms & Conditions Apply)



Coloured Decking Screws



Hidden Fastener System

The Castlewood hidden fastener system features three clips, the TC1 locks and secures the board down (Locking Fastener), the TC2 allows for expansion and contraction (Control Expansion & Contraction - CEC Fastener), so that you don't experience warping or distortion of any kind after installation. The TC5 is used to lay the boards at the start and end of the layout. The system works because it allows the user to control the direction in which the expansion and contraction will take place.



TC1 - Locking Fastener TC2 - CEC Fastener TC5 - Start/End Fastener

Facia Boards, Trims & End Caps



End Caps
All Castlewood End Caps are made of TPO Plastic which is durable and has high impact resistance under harsh weather conditions and extreme low temperatures of -40°C.



L Shaped Angle
Suitable for finishing any 90 degree angles around your decking layout.



Facia Board
Facia Boards can be used around the external perimeters of your decking to create a high quality professional finish.



Bullnose Edge Board
An edge board to allow a safe and seamless finish to your deck.

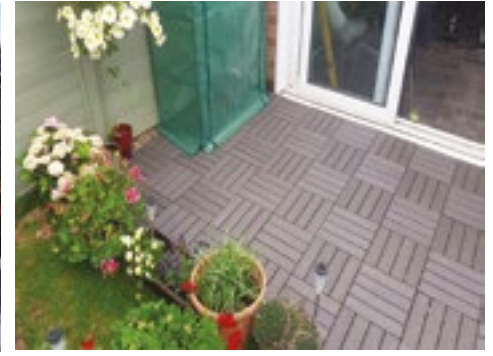

Composite Deck Tiles



Wood Plastic Composite Quick Deck Tiles

The Castlewood Quick Deck Tile is a 100% eco-friendly capped composite deck tile comprised of natural wood grains and an interlocking base for a quick and easy installation. Also, the decking tiles will not bend, warp, split, or crack so not only is it easy to install it is virtually maintenance free.

The Castlewood Capped Composite Deck Tile's interlocking system is also raised to allow for proper drainage of water avoiding pools that could be created during heavy rain. This innovative interlocking deck tile was designed to be used by anyone from DIY beginners to veteran builders looking for an attractive, easy to install deck.

Overall, this Capped Deck Tile is a great alternative for anyone that wants to do a day project by themselves rather than hire a professional for a couple of days to build an entire deck.

Colours: Teak, Silver Grey, Ebony, Antique

Technical Information

Dimensions: 300 x 300mm & 600 x 300mm

Composition: High Density Polythene Plastic Wood Fibre.

5 Year Limited Warranty.

Thickness: 20mm

When laying on flat roofs or balconies use with our 3mm rubber granulate underlay (see page 59) to protect the waterproofing and reduce noise transfer between the tiles and the surface below

Ramp Edge Facias



Colours: Teak or Silver Grey

Technical Information

Interlocking design for easy installation.

Suitable for use with 300x300mm and 600 x 300mm tiles.

300mm Lengths (Packs of 4).

Corner Edge Facias

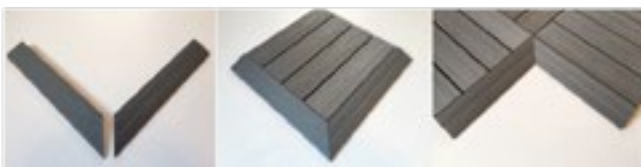

Colours: Teak or Silver Grey

Technical Information

Interlocking design for easy installation.

Suitable for use with 300x300mm and 600 x 300mm tiles.

Internal & External Corners Available.

Castlewood Railing System



CASTLEWOOD RAILING SYSTEM



Castlewood railing is attractive and easy to install with its innovative pre-welded panels and simple bracket systems. Castlewood railing will greatly reduce on-site installation time and with its range of components, the versatility of our railing offers almost limitless customisation possibilities irrespective of installation size. The range of components provides superior performance in strength and safety and with quality welding and premium powder coating.

Our railing is a high quality, long lasting handrailing solution. It is made from pre-galvanised steel, which is then sprayed with a protective zinc phosphate coating, then treated with a further coating, before finally getting treated with a high quality Akzo Novel UV resistant powder coated finish.

If you require prices or confirmation of the parts required for your project please send us a sketch or drawing of the area and we will calculate the materials required.



Angle Railing Bracket



Fixed Railing Brackets



50/75mm Post Caps



50/75mm Posts



Fixed Railing Panels
2370mm and Adjustable
Railing Panels 2320mm

Ultraguard Composite Fencing



Our Ultraguard composite fencing system looks amazing and is both easy to use and cost effective, enhancing any garden and creating a contemporary focal point. The system is manufactured by combining waste wood particles and thermoplastic resin. It is waterproof, strong and easy to maintain. Available with bolt-down and concrete-in aluminium post options.

Features & Benefits

- Create a secure acoustic barrier
- Long-lasting and low maintenance
- Polymer capped board for increased protection and UV stability
- Boards available in 5 colours
- Standard fence height 1.8m with 1.8m post centres
- Aluminium concrete-in or bolt down posts options available
- Posts & boards can be cut to create a lower or narrower fence
- Panels are built quickly using tongue & groove boards
- No more frost damaged, cracked or chipped concrete posts
- Easy to carry and deliver; much lighter than concrete posts

Dimensions & Usage Info

- Standard panels are 1.8m high and 1.8m wide. Posts can be cut down if required to form a lower fence.
- Concrete In Post – 80 x 2400mm
- Bolt Down Post – 80 x 1900mm
- Infill Boards (Supplied in packs of 4) – 150 x 1760mm – 12 boards per 1.8m high panel
- Reinforcement Bars (Supplied in packs of 4) – 20 x 10 x 1760mm – 4 bars per 1.8m panel

Colours

Ebony/Antique/Teak/Silver Grey/Oak

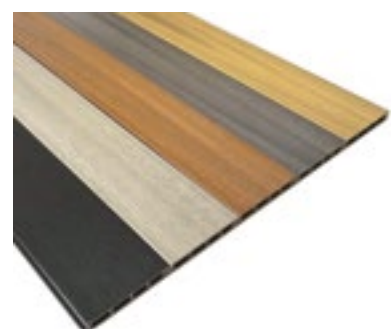

Castle Composite Cladding

Castle composite cladding provides an environmentally friendly and sustainable alternative to natural wood cladding. Its installation is simple, and it offers a vibrant grain texture with a unique blend of colours that create a realistic engineered effect. Available in Walnut, Graphite, Teak and Antique colours.

Not only is Castle composite cladding aesthetically pleasing, but it is also made from recycled materials, making it an eco-friendly choice.

Castle composite cladding is highly durable, thanks to its outer shell that encapsulates the board, providing protection against scratches and fading. In addition, it can protect exterior walls from the elements and improve thermal conductivity and acoustic performance, offering a long-lasting layer of protection.



Accessories



Facia:
2.5m x 70mm x 11mm or
2.5m x 140mm x 11mm



L Trim:
3m x 50mm x 50mm



Starter Clips



Coloured Screws



Walnut



Teak



Graphite



Antique

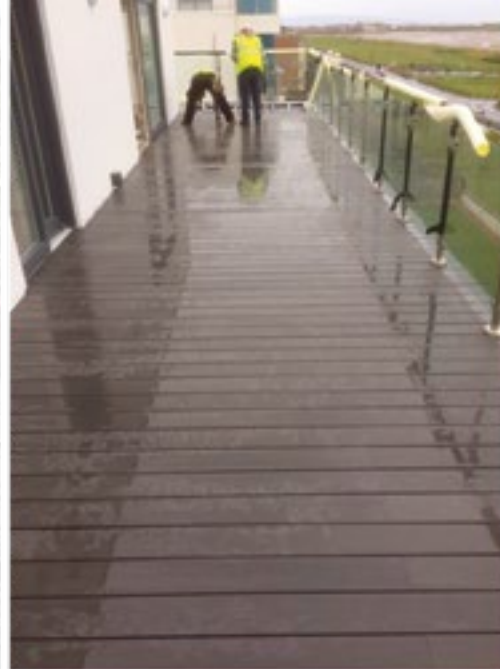
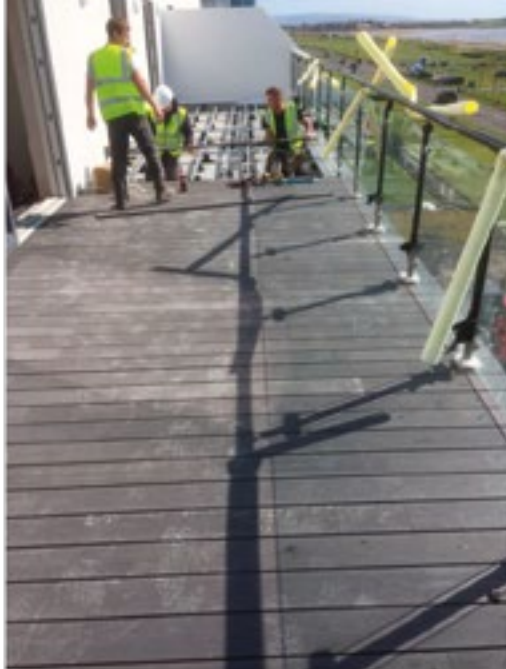

Aslon® Terrace Decking Substructure System

**Class A1
Fire Rated**

ASLON® TERRACE DECKING SUBSTRUCTURE SYSTEM



The Aslon aluminium decking joist substructure system is designed specifically for universal, straight forward and fast assembly of composite decking on flat roofs, balconies and terraces. The system will work with any decking board that has a groove of at least 3.5mm in height and 8mm in depth.

With the Aslon Any Deck substructure system you can save 50% or more on installation time.

Universal

The system can be used for wood composite, synthetic, bamboo and hardwood decking. The aluminium beams are always straight unlike the hardwood alternative.

What materials do you need?

Simply contact us with your measurements and decking board type. We will then calculate all the items required for installation.

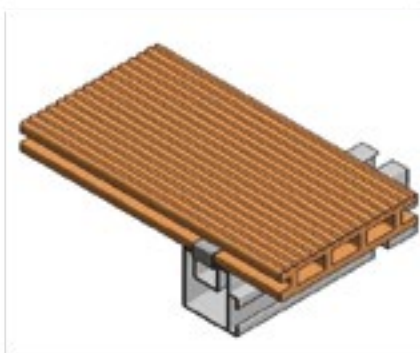

End Fastening Clamp

End Fastening Clamps are used to fasten the first and last boards of the layout. Pushes into the ends of the aluminium beam to secure the first and last decking boards where possible.



Fastening Clips

Fastening clips are used to secure the decking boards to the aluminium beams. These clips can be loosened to allow removal and replacement of boards at any time without damage to the decking boards or substructure





Aslon® Any Deck - Porcelain Tile Substructure

**Class A1
Fire Rated**

The ASLON Aluminium Substructure is available with paving spacers allowing the aluminium system to be used with 20mm thick external porcelain tiles.

As this system is lightweight, restrains all tiles from movement and can be easily dismantled for access it is ideally suited to flat roofs, balconies and patio applications.

Paving Spacers are used to give a 3mm spacing between tiles for drainage purposes. These spacers can be loosened to allow removal and replacement of tiles at any time without damage to the tiles or substructure

Start/End Fasteners are used to secure the first and last tiles of the layout. Start/End Fasteners can also be used to joint beams together reducing the need for multi brackets

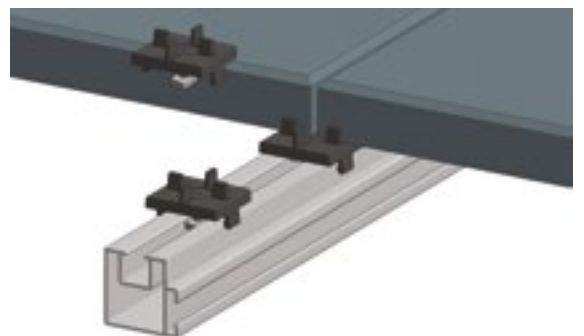

Aslon® Any Deck Substructure Component Parts



Coupler

Couplers are available where aluminium beams need to be joined. Couplers are fixed using the same quick fit connection as the fastening clips keeping installation time to a minimum and ensuring a secure connection.



Multi Brackets

Multi Brackets can be used to attach the aluminium beams to almost any surface including timber, concrete and even existing pavers.

The Multi Bracket can also be used to connect aluminium beams together at 90 degree angles where required. Can only be used with 40 x 40mm beams.



Installation On Rubber Pads

Installation on our Aslon rubber pads is quick and easy. Aslon rubber pads are 100 x 100 x 10mm in size and will protect the substrate below from damage as well as allowing for free drainage. When installing on Aslon Pads the decking will simply follow the existing fall of the roof. Please contact us if you have an area with multiple fall directions. Supports should be placed under the aluminium beams no more than 500mm apart.



Installation on Adjustable Pedestals or Adjustable Decking Cradles

Installation on our adjustable supports allows for complete adjustment of the deck level. Using this system the decking can be installed level by adjusting the height of the supports to overcome the drainage falls of the roof. Our slope correction supports automatically adjust for the angle of drainage and fit perfectly to the aluminium beams. Supports should be placed under the aluminium beams no more than 500mm apart.



ASLON Aluminium Beams

ASLON Aluminium Beams are always straight and provide a very light weight substructure for porcelain tiles. Installation can be on our Aslon Rubber Pads, Decking Supports or Adjustable Slope Correction Pedestals.

Always install the aluminium beams (substructure) in accordance with the installation manual to which reference is made by the manufacturer of the porcelain tiles.

Available Sizes

40 x 40 x 2200mm

35 x 23 x 2200mm

4000mm beams available for special order





Artificial Grass

Castlegrass Range

Castlegrass offers not only a cost effective and time saving alternative to natural grass but also keeps the high quality effect of a naturally laid turf. Castlegrass can be used on both commercial and residential properties. Artificial grass is fast becoming the perfect solution for gardens throughout the UK due to the time and money saved after it has been installed. This is due to virtually no maintenance being required after the grass has been laid. This saves time and money on cutting, feeding, watering and numerous other chores that its counterpart natural grass has.

4m rolls

(Deluxe now available in 2m and 5m rolls, Ultra available in 5m rolls)

Deluxe:	33mm, 2680g/m ²
Ultra:	40mm, 2950g/m ²
Elegance:	40mm, 2690g/m ²
Select:	27mm, 1640g/m ²
Elite*:	40mm, 2995g/m ²
Deluxe Striped:	33mm, 2680g/m ²
Golf Plus:	16mm, 2800g/m ²

**Elite has a special PU backing that makes it easier to cut and handle. It is also less susceptible to creasing than traditional latex backed artificial grass.*

The standard length of these rolls is 25m but they can be cut to a specific requirement up to 25m.

We also offer a cost effective range of used astro turf, with or without line markings, please contact us for further details.



Castlegrass Laying Guide



Step 1 – Apply Foundation For Artificial Grass



Step 2 – Apply Membrane/Pressure Distribution Cloth



Step 3 – Cut Artificial Grass To Size



Step 4 – Joining Two Parts Of Grass Together



Step 5 – Fit Ground Pins and Apply Sand to the Grass



Step 6 – Enjoy

Castlegrass Accessories

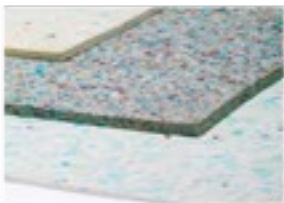

Foam Underlayer



Self Adhesive Jointing Tape

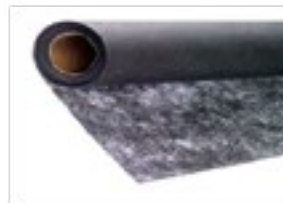

Pressure Distribution/
Weed Membrane



Stainless Steel Ground
Pins



Jointing Tape



Jointing Adhesive

Samples

It is very difficult to demonstrate the quality of Castlegrass through a website or brochure so we are more than happy to provide samples of our full range of artificial grass free of charge. Furthermore, we operate with a 24hour courier service so delivery time is kept to a minimum. To arrange for a sample to be sent please contact us via phone or email.



**Very low maintenance ▪ Massive time saver ▪ Don't need to water ▪ UV resistant
Don't need to feed ▪ Pet friendly ▪ No dirt ▪ Long lasting ▪ No Cutting ▪ 8 Year Guarantee**



GrassForce Rubber Matting

Colour options: 1, Black
 Size: 1000 x 1500 x 22mm

Grass Force is an environmentally friendly, rubber reinforcement and safety mat manufactured from recycled rubber. Our rubber matting otherwise known as grass matting or ring matting, can be used in many environments including play areas, golf courses, ice rinks, ski slopes, access walkways, pathways and behind bars, often for the mats ability to maintain grass growth in areas of frequent foot traffic.

Benefits of Grass Force include:

- Absorbs shock and noise
- Moulded anti-slip cellular structure has excellent durability and comfort
- Allows for a firm bond to the ground, hiding the matting through grass
- High ground drainage and erosion protection in areas of frequent foot traffic
- No costly base works
- Quick and easy installation
- Requires no special tools
- Can be used on flat or sloped landscapes
- Easy maintenance
- Grass can be cut as usual

Grass Force pegs are also available for installation. We recommend four pegs per mat. Mats can also be connected using black cable tiles if required.



1 week



3 months



Gravel Grids Ground Reinforcement

The Classic Gravel Grid is versatile and easy to lay. As they interlock they can be laid quickly to provide additional strength and retention to gravel walkways and roads.

Our Classic Grids in black are manufactured from 100% recycled plastic.

The Classic Grid in black is very high quality and our most cost effective grid.

Technical Details

Width: 592mm
 Length: 790mm
 Thickness: 30mm
 Mats per m²: 2.14

Tested Loading Unfilled: 256 Tonne/m²
 Tested Loading Gravel Filled: 3186 Tonne/m²

Installation



The appropriate base is determined by the substrate and expected use. Generally described, the foundation for walking areas should be a layer of sharp sand 10cm. For use with cars and compacted layer of hardcore 15-20cm plus 4-6cm sharp sand.



Create the edges with aluminium, galvanised steel, wood or PVC. Height (10-15cm) and thickness depending on expected use. Use inner alignment where possible to achieve the correct levels.



After compacting the sand layer is flattened and excess sand removed. Also remove contaminants or sharp objects.



Create the custom plates along the sides or around obstacles using a manual or power saw.



Fill the grids with gravel in such a way that the layer arises 15-20mm above the plates.



Rake the gravel and spread it evenly. Maintenance is limited to the removal of leaves, dirt and occasionally raking. Make up where necessary so that the plates are completely covered with gravel.

dFLECT RUBBER PLAYGROUND TILES



Grassflex Play



Our Grassflex Play range is manufactured in the same way as the standard Grassflex tile but with a much brighter and vibrant choice of colours to make your playground look as exciting as possible.

Grassflex Play are available in 500 x 500 sizes from 25mm to 100mm thick.

Available in Black, Red, Green, Yellow, Blue and White.

As the recycled rubber underlayer is covered by the artificial grass, carbon leaching will never be an issue.

Tested in accordance with EN1175 & EN1176. Test reports available upon request.



dFLECT SBR Rubber

Our range of dFLECT rubber tiles have been designed and manufactured to cushion falls as well as give a slip resistant surface finish. dFLECT Rubber Tiles have channels on the underside to provide excellent drainage properties and impressive critical fall height results. Our dFLECT rubber tiles are also a sustainable product as they are made from recycled rubber granulate.

All our playground tiles are tested in accordance with EN1176 & EN1177. Please refer to the table for exact results. Test certificates are also available on request.

Available in 400 x 400mm, 500mm x 500mm & 1000 x 1000mm. Colours include Black, Red, Green, Grey and Sand.



Thickness

- 25mm
- 30mm
- 40mm
- 45mm
- 50mm
- 65mm
- 100mm

Fall Height

- 0.8m
- 1.0m
- 1.45m
- 1.5m
- 1.6m
- 2.05m
- 3.0m

Weight

- 16.80kg/m²
- 19.20kg/m²
- 21.60kg/m²
- 25.60kg/m²
- 29.60kg/m²
- 31.20kg/m²
- 36.80kg/m²



Ramp Edge Tile



Corner Edge Tile

We also offer a range of interlocking edge and corner tiles in the different colours. These are commonly used to eliminate trip hazards on entry to an area.



dFLECT EPDM

dFLECT EPDM tiles are also available for playgrounds. These tiles are slightly different as they are made from EPDM rubber granulate only rather than recycled granulate. Furthermore, they are available in a wider variety of colours and some very unique effects can be created with EPDM tiles.

The EPDM tiles are more expensive than their recycled counterpart due to EPDM granulate being used in the manufacturing process. However, the tiles are also more UV stable than the recycled tiles.

EPDM is an abbreviation of Ethylene Propylene Diene Monomer. Our EPDM tiles have a top layer as per your colour choice and the remainder of the tile will be black. As EPDM tiles have little or no chance of carbon leaching, we recommend their use where young children will be crawling on the tiles.



PU Adhesive XP2435

Our XP2435 adhesive is specially formulated to adhere to almost any surface including concrete and timber.

The adhesive is commonly used when laying our non interlocking tiles and our interlocking tiles along open edges. This stops the movement of the tiles and also prevents wind uplift. Please note, if the tiles are against an edge at the sides the adhesive is not necessary as the edge shall act as the restraint when using interlocking tiles.



Softbox Formers



Softbox Coupled Wall Sections

Manufactured from recycled rubber granulate in 1000 x 300 x 150mm sections. These sections can be coupled together to form longer lengths or corners by means of a metal tube which is anchored in the ground.

Available in Black, Red and Green



Softbox Wall Block

Manufactured from recycled rubber granulate in 1000 x 300 x 150mm blocks.

The blocks are used in sunken sandpits where the surrounding pavement elements hold the assembly in place.

Available in Black, Red and Green



Softbox Palisades

Manufactured from recycled rubber granulate in 250 diameter x 400mm or 600mm high columns. These circular column sections with curved notches are fixed to the substrate by dowels on the underside and can be used to form curved and shaped walls and to link other elements in irregular shaped sandpits.

Available in Black, Red and Green

Softbox Liners



Softbox Edge Liner/ Ramp

Manufactured from recycled rubber granulate in 1000 x 400 x 150mm sections

The edge liner is fitted to the top edge of the sandpit wall and covers the edge but also has a sloping ramp profile at the outer edge to allow safe access to the sand pit.



Softbox Wall Liner

Manufactured from recycled rubber granulate in 1000 x 250 x 50mm sections.

Wall liners can be adhered to the lower wall sides and can be fitted to any depth by cutting or joining additional liners.

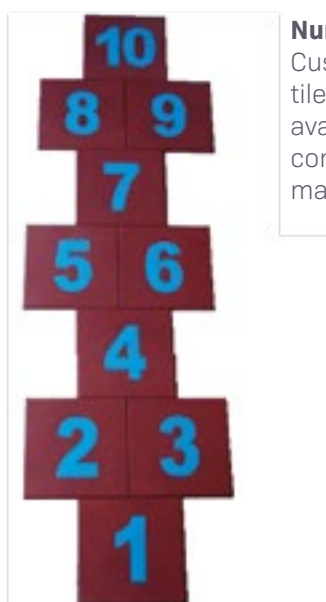

Numbered Playground Tiles

Customised playground tiles with numbers are also available in a range of colour combinations. These tiles are manufactured to order



dFLECT Gym Flooring

Puzzle Gym Floor Tiles

Rubber gym mats with puzzle style interlocking design provide a seamless floor for activities in the gym including flexibility exercise, dynamic strength, static strength training and aerobic exercise.

Our mats are manufactured from high quality recycled rubber. All our mats are toxicity tested and made to a high density of 1000kg/m³ for exceptional durability.

Our rubber puzzle gym mats will provide sound and impact protection for your gym floor whilst remaining easy to clean and aesthetically pleasing.



Yellow Fleck



Green Fleck



Blue Fleck



Red Fleck



Grey Fleck

Material composition: recycled granulate bound using a PU binding agent

Size: 478x478mm & 956x956mm at 8 & 16mm thick

Colours: Black, Black/Green, Black/Yellow, Black/Blue, Black/Red, Black/Grey.

Density: 1000 kg/m³

Fire resistance: Efl to EN 13501

Smoke resistance: S2

Size tolerance: width 2% and thickness 5%

Carbon black: carbon black is a black colouring agent which exists in every rubber tile and which can come out due to influences of the weather

Quicklime/cement veiling: due to weather influences and quicklime/cement veiling of the surrounding objects the tiles and mats might develop a white efflorescence

Guarantee: 3 year guarantee for wear-resistance, when used for fitness purposes. The guarantee does not apply to colour.

Our dFLECT range of rubber tiles shown on pages 52-54 are also commonly used in gyms.

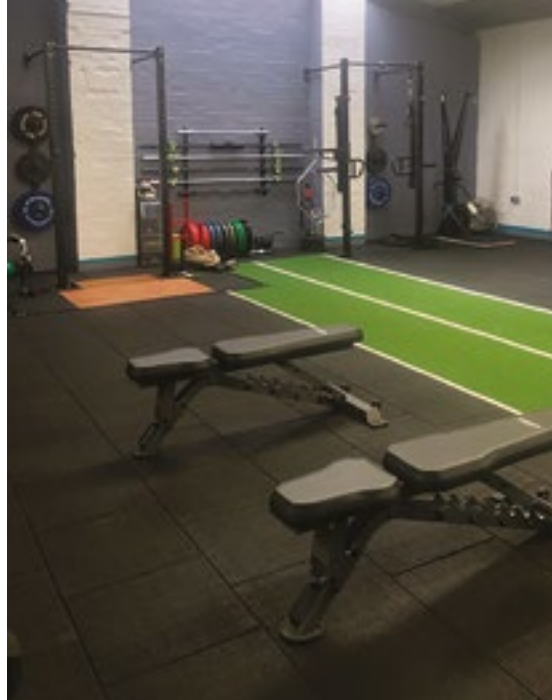

Fine Granulate Gym Tiles

Fine granulate rubber tiles manufactured and designed for gym applications.

The use of very fine recycled rubber granulate in this range gives the tile a sharper surface finish and also makes them easier to keep clean when installed.

The tiles come with a flat or stud underside with edges and corners also available.

Available in the following sizes and density.

Fine Granulate

Available Densities - 800kg/m³, 900kg/m³ & 1000kg/m³

Granulate - 0.7-1mm

Available Sizes - 500 x 500 x 20mm/30mm/40mm/45mm, 1000 x 1000 x 20mm/30mm/40mm/45mm



Sprint Tracks

Our sprint tracks have been specially developed for intensive use. Due to the combination of a short pile and high density, the mat is very wear-resistant and therefore lasts a long time as a sports floor. It is easy to install and suitable for indoor and outdoor use.

Type 1 - Sprint Track with Lines

Available Sizes - 2 x 25m, 2 x 15m, 2 x 12m, 2 x 10m

Weight - 2.214g/m²; Total Height 14mm;

Colours - Black, Green, Red and Blue



Type 2 - Sprint Track with 1-10 and start/finish

Available Sizes - 2 x 12m

Weight - 3.8g/m²; Total Height 22mm;

Colour - Green



Rubber Equestrian Tiles

The benefits of dFLECT Rubber Equestrian Tiles:

- Low likelihood of slip
- Reduction in injuries
- Urine and water permeability
- Insulating
- Soundproofing

- Comfortable
- Elastic
- Shape
- Frost resistant to -40°C
- Heat resistant up to 80°C
- Weather and wind resistant

dFLECT Equestrian rubber mats and wall products are designed, manufactured and tested specifically for Equine use. They are not standard playground rubber tiles or mats re-branded.

Horse Stall walls and floors are often made of concrete which, with its hard and often rough or slippery which can cause injuries to the animals. dFLECT Rubber Wall & Floor Mats can significantly reduce the risk of injury. Also by covering the exposed surfaces, the life of the stall is significantly extended.

Stable and External Walkways used for the exercise of horses are usually made of concrete or densely compacted aggregate. Because of the hard and sometimes slippery surface this produces the animals can suffer injuries. dFLECT rubber floor tiles can significantly reduce these risks. The dFLECT H-block and H-mat are suitable for floors in stable aisles, estates, walkways and carousels. The H-Block and H-Mat are manufactured from recycled rubber granules, dye and polyurethane, densely compressed to ensure long life and durability.



dFLECT Equestrian H-Mat Rubber Tiles

Colour options: 4; Size: 1120 x 1000 x 30-43mm

The dFLECT H-mat interlocking profile allows installation to be carried out quickly, easily and without obvious seams. The integral drainage channels built into the underside of the mat allow water and urine to quickly drain away.



dFLECT Equestrian H-Block Rubber Tiles

Colour options: 3; Size: 200 x 165 x 43mm
35 blocks per m2

The dFLECT H-Block can be used on any hard surface. The H-profile of the blocks ensures an interlocking effect when blocks are placed in the interlock pattern. This product is available in black, red and green.



dFLECT Stable Floor and Wall Mat Rubber Tiles

Colour options: 2;
Size: 1000 x 1000 x 30/40mm and 1000 x 500 x 55mm

The hard and often rough surfaces of the side walls of the stall can frequently cause injury to the animal and can also be damaged by the horse. Covering with dFLECT Stable Wall Mats can prevent serious injury to the animals, and damage to the walls can be prevented. Horse boxes can also be protected by the application of this product.

Acoustic Protection

ASLON Rubber Underlay Acoustic Protection

Size: 1.25 x 10m x 3mm, 6mm & 10mm
Density - 730kg/m³
Recycled Rubber Granulate

ASLON rubber underlay acoustic protection matting rolls are manufactured from high-density recycled rubber granulate and are available in thicknesses of 3, 6 and 10mm. Due to the flexible and durable nature of this matting it has a wide range of applications as listed below.

ASLON rubber protection mats help prevent damage to surfaces and structures from foot traffic, maintenance work, high loads, point loads, abrasives and vibration. They also offer excellent resistance to mould and algae as well as acoustic and thermal insulation.

Feel free to call and discuss your project further.

Applications:

Roofing; Structural Engineering; Solar Installations; Civil Engineering; Flooring; Transport; Industrial

Benefits:

- Easy to lay
- Flexible
- Permeable
- Environmentally friendly
- Excellent anti vibration qualities
- Low noise transfer
- Thermal insulation



flat roofs and balconies. As well as offering excellent protection to the waterproofing they raise the paving above the membrane to allow for drainage. Aslon shims can also be used to adjust over slight undulations.

We recommend the use of our Promenade Slabs that are fully tested to BS 1339 for use on support pads to avoid breakages and damage to the waterproofing.

Timber Decking

Suitable for use when laying timber decking on flat roofs or balconies. The pads protect the waterproofing as well as support and raise the joists to allow water to flow accordingly. The pads also reduce noise transfer from trafficking due to their rubber composition.

The applications listed above are only a fraction of the uses for Aslon rubber pads. Please feel free to contact us if you have further questions on their suitability.



Aslon Protection Pads Acoustic Protection

Aslon rubber protection pads are commonly used on flat roofs and balconies as protection pads for many applications, some of which are listed below. Manufactured from recycled SBR rubber they offer an

anti slip protection surface that is also very effective for noise deadening. Stock pad sizes are 100x100x10mm and 200 x 200 x 10mm. Other sizes are also available on request.

Solar Panels

Aslon protection pads are commonly used under solar consoles and panel frames to protect the waterproofing surface from damage due to point loading & vibration. As the pads have excellent anti slip properties they also helps to keep solar consoles in position.

Flat Roof & Balcony Paving

Aslon protection pads can be used to lay paving on





Ladder Mats

Manufactured from a mix of high performance rubbers, polymers and catalysts they provide an anti-slip low noise transfer base for ladders. The benefits of which include:

- Reduced chance of movement at the foot of the ladder.
- Protects the surface on which the ladder would normally stand from damage.
- Reduces wear on ladder legs
- Decreases noise transfer between ladder and surface below.

Falls from height remain the most common cause of workplace fatality. In 2017/18 there were 37 fatalities and 5605 reported non fatal injuries that caused the injured person to be off work for 7 days or more due to a fall from height.

The Aslon Ladder Mat will reduce the likelihood of having an accident on a ladder and is a must have for anyone who uses a ladder.

Available in 1m & 1.3m widths.



Delivery Information & Terms and Conditions

Pallet Deliveries:

Deliveries made by pallet will be delivered on a curtain sided 18T vehicle with tail lift. The driver will endeavour to call ahead on the agreed delivery date if a mobile number is provided for the customer. Driver will off load the pallet using the tail lift to the roadside.

We must be made aware of any address with access restrictions that will not allow a 18T vehicle to deliver. Deliveries can be made using 7.5T vehicle upon request. 7.5T vehicles must be requested before the pallet is despatched or a fee will be charged. 7.5T vehicle tail lifts have a lower limit of 750kg per pallet so an additional charge may apply if the order has to be broken down over more pallets.

If a delivery is required at a certain time of the day we can book this for an additional fee. This will allow us to book a 1 hour window for delivery after 10am.

Where deliveries fail due to access restrictions or nobody being at the address to sign and accept the goods, a redelivery charge will be incurred.

We will not accept any liability for any consequential costs associated with late deliveries, failed deliveries or incorrect goods being delivered.

Damages:

Damages must be reported to us within 5 working days of delivery. This is due to insurance terms placed upon us by the delivery company. Any damages must be photographed on the pallet as delivered and submitted along with your claim. We will not accept any claims that have photos of goods not on the pallet as delivered, as we cannot then prove to the transporter that the damage was caused during transit.

Returns:

All palletised orders will be subject to the following deductions where a return is requested by the customer:

- Cost of pallet being sent out
- Cost of pallet being collected and returned
- Inspection and restocking fee

Where a forklift is not at the return collection address we can only collect pallets from the position they were delivered to due to limitations with manual pallet trucks and tail lifts.

Pallets can only be collected at a maximum weight of 750kg due to tail lift restrictions. If the pallet weighs more the goods may need to be split over two pallets by the customer

Upon inspection any goods that are not fit for re-stocking will be deducted from the credit.

The packaging for orders being returned should be the same as when they arrived otherwise damage in transit is very likely.

All returns require a photograph of the pallet ready for collection before we can book it in. We also advise taking a photo of the pallet when it has been loaded onto the truck.

Pallets containing concrete products that have been stored outside are very unlikely to be unacceptable for return.

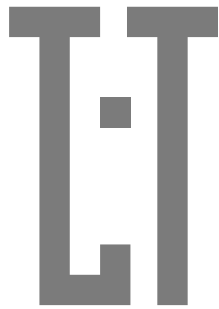

▪ EST 1998 ▪

Castle Composites Ltd
Nisbet Way, Ravenstruther
Lanark ML11 7SF

Tel: 01555 870 003

Fax: 01555 870 040

Email: sales@castlecomposites.co.uk

Web: www.castlecomposites.co.uk